

# MEASURING MATERIAL FLOWS AND RESOURCE PRODUCTIVITY

Volume II.  
The Accounting Framework





# **MEASURING MATERIAL FLOWS AND RESOURCE PRODUCTIVITY**

**Volume II.  
The Accounting Framework**



## ORGANISATION FOR ECONOMIC CO-OPERATION AND DEVELOPMENT

The OECD is a unique forum where the governments of 30 democracies work together to address the economic, social and environmental challenges of globalisation. The OECD is also at the forefront of efforts to understand and to help governments respond to new developments and concerns, such as corporate governance, the information economy and the challenges of an ageing population. The Organisation provides a setting where governments can compare policy experiences, seek answers to common problems, identify good practice and work to co-ordinate domestic and international policies.

The OECD member countries are: Australia, Austria, Belgium, Canada, the Czech Republic, Denmark, Finland, France, Germany, Greece, Hungary, Iceland, Ireland, Italy, Japan, Korea, Luxembourg, Mexico, the Netherlands, New Zealand, Norway, Poland, Portugal, the Slovak Republic, Spain, Sweden, Switzerland, Turkey, the United Kingdom and the United States. The Commission of the European Communities takes part in the work of the OECD.

OECD Publishing disseminates widely the results of the Organisation's statistics gathering and research on economic, social and environmental issues, as well as the conventions, guidelines and standards agreed by its members.

*This work is published on the responsibility of the Secretary-General of the OECD. The opinions expressed and arguments employed herein do not necessarily reflect the official views of the Organisation or of the governments of its member countries.*

© OECD 2008

---

No reproduction, copy, transmission or translation of this publication may be made without written permission. Applications should be sent to OECD Publishing: [rights@oecd.org](mailto:rights@oecd.org) or by fax (33 1) 45 24 99 30. Permission to photocopy a portion of this work should be addressed to the Centre français d'exploitation du droit de copie, 20, rue des Grands-Augustins, 75006 Paris, France ([contact@cfcopies.com](mailto:contact@cfcopies.com)) or (for US only) to Copyright Clearance Center (CCC), 222 Rosewood Drive, Danvers, MA 01923, USA, fax 1 978 646 8600, [info@copyright.com](mailto:info@copyright.com).

---

## INTRODUCTION

This report is part of the **OECD work programme on material flows (MF) and resource productivity (RP)** that supports the implementation of the OECD Council recommendation on MF and RP adopted in April 2004. It is the second volume of a **series of guidance documents on *Measuring material flows and resource productivity*** that have been drafted in a joint effort by a group of experts from OECD countries led by the OECD Secretariat<sup>1</sup>.

This volume provides a theoretical and technical description of the concepts and principles of **Material Flow Accounting (MFAcc)** and of their application at the national level. It has been drafted by Aldo Femia in co-operation with a team of experts<sup>2</sup>. It benefited from contributions by members of the OECD Working Group on Environmental Information and Outlooks, of the Eurostat Task Force on Material Flows, of the London Group on Environmental Accounting, and of the United Nations Committee of Experts on Integrated Environmental Economic Accounting. In developing this report, the co-operation of statistical services and material flow experts in countries has been invaluable. Our sincere thanks are therefore extended to all concerned.

The guidance documents provide **guidance on methodological and measurement** issues related to material flow analysis (MFA), including the development of material flow accounts and related indicators. Emphasis is put on tools that can be used by country governments to support the development and implementation of **national policies** and related **international work**. The guidance documents reflect the **state of the art** concerning experience with material flow analysis and related indicators in member countries. It is expected that they will evolve as ongoing efforts on methodologies and measurement systems will show results and as more feedback will become available on the policy uses of MF information and indicators.

The work has benefited from a **sequence of workshops** hosted by member countries (Helsinki, June 2004; Berlin, May 2005; Rome, May 2006; Tokyo, September 2007), that brought together environmental administrations, statistical services, material flow experts and researchers.

The guidance documents include:

- **Volume I. The OECD guide.**

Volume I describes the full range of MF approaches and measurement tools, with a focus on the national level and emphasis on areas in which practicable indicators can be defined. It is targeted at a non expert audience. It includes (i) an overall framework for material flow analysis (MFA), (ii) a description of different kinds of measurement tools, (iii) a discussion of those issues and policy areas to which MFA and material flow indicators can best contribute, and (iv) guidance on how to interpret material flow indicators. It is illustrated with a selection of practical examples from countries' experience and is complemented with a glossary.

- **Volume II. The accounting framework.**

Volume II provides a theoretical and technical description of the concepts and methodologies of material flow accounting. It is targeted at an expert audience. It draws upon the Handbook

<sup>1</sup> Experts and consultants: Mr. Derry Allen, Mr. Stefan Bringezu, Mr. Aldo Femia, Mr. Tomas Hak, Mr. Jan Kovanda, Mr. Yuichi Moriguchi, Mr. Heinz Schandl, Mr. Karl Schoer, Mr. Eric Turcotte, Ms Aya Yoshida. OECD Secretariat: Ms Myriam Linster. The financial and in-kind support of the Czech Republic, Finland, Germany, Italy, Japan, Luxembourg, and the United States is gratefully acknowledged.

<sup>2</sup> Document drafted by Aldo Femia (ISTAT, Italy) with inputs from Heinz Schandl (IFF-Vienna, Austria), Karl Schoer (DESTATIS, Germany), Ole Gravgard (Statistics Denmark) and members of the Eurostat Task Force on Material Flows. It draws upon chapter III of the 'Integrated Environmental and Economic Accounting 2003' handbook (commonly referred to as SEEA 2003; United Nations, *et al*, 2003.) and on Eurostat (2001), *Economy-wide material flow accounts and derived indicators – A methodological guide*. European Communities, Luxembourg

on national accounting - Integrated Environmental and Economic Accounting (the SEEA handbook), developed jointly by the United Nations, the European Commission, the IMF, the OECD, and the World Bank and on the guide published by Eurostat in 2001 Economy-wide material flow accounts and derived indicators – A methodological guide. It has benefited from co-operation with Eurostat and with the London Group on Environmental Accounting, and consultations with the UNSD and its Committee of Experts on Integrated Environmental Economic Accounting.

- **Volume III. Inventory of country activities.**

Volume III takes stock of activities related to the measurement and analysis of natural resource and material flows in place or planned in OECD countries and in selected non member economies. It describes the main features that characterise such activities and the extent to which information on material resources is used in environmental reporting and in decision making. It is designed to provide a factual basis for the further exchange of experience and information, and for sharing lessons at international level.

- **Volume IV. Implementing national MF Accounts** (forthcoming, prepared jointly with Eurostat).

Volume IV provides practical guidance to assist countries in implementing national material flow accounts. It is targeted at practitioners of material flow accounting. It is constructed in a modular way to reflect several levels of ambition and completeness of accounts, and is being developed stepwise. The first edition will focus on the establishment of simple economy-wide material accounts building on a set of core tables tested and used by Eurostat.

The guidance documents are complemented by a **synthesis report** that summarises the work carried out, takes stock of progress made, and adds selected examples from applications of MFA. They are published on the responsibility of the Secretary General of the OECD.

# MEASURING MATERIAL FLOWS AND RESOURCE PRODUCTIVITY

## The Accounting Framework A theoretical framework for material flow accounts and its applications at national level

<b>INTRODUCTORY NOTE</b>	<b>9</b>
<b>Chapter 1. GENERAL CONCEPTUAL AND METHODOLOGICAL FRAMEWORK</b>	<b>13</b>
<b>1. Basic concepts and principles</b>	<b>13</b>
1.1. Materials and activities	13
1.2. Systems and subsystems	14
1.3. Flows and stocks	14
<b>2. Internal, cross-boundary and external flows</b>	<b>15</b>
2.1. System boundaries	15
2.2. Open and closed material systems	15
2.3. Material inputs and outputs	16
<b>3. Categories of flows</b>	<b>16</b>
3.1. Used and unused materials	16
3.2. Direct and indirect flows	17
<b>4. The law of conservation of matter and the mass balance principle</b>	<b>17</b>
4.1. Supply-use, input-output and material accumulation identities	18
4.2. The different meaning of the balancing for materials and transformation activities	18
<b>5. Representation of material flows through physical supply-use and input-output tables</b>	<b>19</b>
5.1. Physical supply-use tables (PSUTs)	19
5.2. Physical input-output tables (PIOTs)	22
<b>6. Internal flows, aggregation by activity and the measure of total flows</b>	<b>23</b>
<b>7. Net flows and aggregation by material</b>	<b>24</b>
<b>Chapter 2. CHARACTERISTICS OF NATIONAL MATERIAL FLOW ACCOUNTS (NMFACC)</b>	<b>25</b>
<b>1. Comprehensiveness, integration between levels, coherence with national accounts</b>	<b>25</b>
<b>2. Quality criteria</b>	<b>26</b>
2.1. Theoretical soundness	26
2.2. Policy relevance	26
2.3. Feasibility	26
<b>Chapter 3. A COMPLETE AND EXHAUSTIVE FRAMEWORK FOR NMFACC</b>	<b>27</b>
<b>1. Introduction</b>	<b>27</b>
1.1. Relation with the SEEA	27
1.2. Objectives	27
1.3. Specification of the focus flows	28
1.4. Outline of the chapter	29
<b>2. Dealing with the socio-economic system as a black box</b>	<b>30</b>
2.1. System boundary	31
2.2. Borderline cases	31
2.3. Main categories of flows	34
2.4. Classifications for different kinds of materials	35
2.5. Example PSUTs	36
2.6. The additions to socio-economic stocks as a net flows aggregate	38

<b>3. Subdividing the socio-economic system according to purely physical concepts</b>	<b>39</b>
3.1. Materials' transformation and accumulation	39
3.2. Roles of the transformation and accumulation subsystems	39
3.3. Example PIOTs describing flows by kind of material	40
3.4. Example PSUTs	41
3.5. Treatment of the internal flows of the socio-economic system and measure of its total flows	41
3.6. Mixed recording of gross and net flows and summary example PIOT	44
<b>4. Subdividing the socio-economic system according to economic concepts</b>	<b>46</b>
4.1. Value flows and material flows: two distinct aspects of human activities	46
4.2. Relation of the economic categories of production, consumption and capital formation to material transformation and accumulation	47
4.3. The importance of production activities in socio-economic material metabolism	48
4.4. Detail by subsystem in the example tables	49
4.5. Flows by kind of material and example PIOTs for products and residuals	50
4.6. Summary example PIOT showing details by kind of materials	53
4.7. Some accounting treatment remarks	53
4.8. Example PSUTs	55
4.9. Further possible subdivisions of accumulation and consumption	57
<b>5. Differentiating production activities to track the internal flows of the production subsystem</b>	<b>57</b>
5.1. Detail by activity	58
5.2. Roles of the different production activities in the circulation of materials by kind and example PIOTs for products and residuals	58
5.3. Example PSUTs	63
<b>6. Introducing the rest of the world (RoW) in the accounting framework: the full-fledged NMFAcc scheme</b>	<b>66</b>
6.1. The residence principle	66
6.2. Overview of material flows between national and RoW systems	67
6.3. Treatment of the RoW socio-economic system and environment	69
6.4. Complete example PSUTs and PIOTs	69
6.5. Subdivision of material flows into transformation chains and balanced PIOTs by transformation chain	73
6.6. Comparing material and monetary aggregates	75

#### **Chapter 4. BREAKDOWN BY ACTIVITY OF THE INPUTS AND OUTPUTS OF THE NATIONAL SOCIO-ECONOMIC SYSTEM AND THE CALCULATION OF ITS INDIRECT FLOWS** **77**

<b>1. The NAMEA approach to material flows as partial realisation of the NMFAcc framework</b>	<b>77</b>
<b>2. The after-extraction approach to breakdown of inputs</b>	<b>78</b>
<b>3. Indirect flows of products and raw material equivalents</b>	<b>79</b>
<b>4. Approaches to the calculation of indirect flows</b>	<b>81</b>
<b>5. Comparison of IOT-approaches</b>	<b>82</b>

#### **Chapter 5. ECONOMY-WIDE MATERIAL FLOW ACCOUNTING (EW-MFAcc) FRAMEWORK FOR NATIONAL SYSTEMS** **85**

<b>1. Objectives and main characteristics of EW-MFAcc and relation with the full-fledged national MFAcc scheme</b>	<b>85</b>
1.1. System boundary	86
1.2. Identification, denomination and classification of materials	88
1.3. Consequences of different system boundary on the quantification of the flows	88
1.4. Supply and use tables at the EW-MFAcc level of aggregation by activity	89
<b>2. Main aggregates of EW-MFAcc</b>	<b>92</b>
2.1. Direct material inputs	92
2.2. Unused domestic extraction	92
2.3. Outputs to the environment	92
2.4. Memorandum items for balancing	92

2.5. Indirect flows of used and unused materials	93
<b>3. Classifications</b>	<b>94</b>
3.1. Material inputs from nature and the rest of the world	94
3.2. Material outputs to nature, landfills and rest of the world	95
3.3. Useful material stocks and stock changes	96
<b>4. Highly aggregated EW-MFAcc and derived indicators</b>	<b>99</b>
<b>5. The composite material balance – derivation of aggregate indicators</b>	<b>103</b>
<b>6. Reconciliation between EW-MFAcc indicators and SNA-coherent measures</b>	<b>104</b>

### List of Figures and Tables

Figure 3.1: Flows between the natural environment and the socio-economic system	35
Figure 3.2: Flows between the natural environment and the socio-economic system and between the transformation and accumulation subsystems	40
Figure 3.3: Flows between the environment, production, current final consumption, capital and other material accumulation	48
Figure 3.4: Material flows between the national socio-economic system and natural environment with the RoW systems	68
Figure 4.1: Direct use of primary materials by economic activities and type of material	79
Figure 4.2: Indirect flows of used and unused materials	80
Figure 4.3: Raw material equivalents for imported products by type of raw material	82
Figure 4.4: Possible IOT-matrixes for calculation of the indirect use of raw material by type of product	82
Figure 4.5: Depiction of the flow of a domestic raw material category through the first stages of the production chain by different types of IOT-matrixes	83
Figure 5.1: Treatment of semi-natural systems in EW-MFAcc with respect to the complete and exhaustive NMFAcc framework	87
Figure 5.2: Composite economy-wide material balance with derived resource use indicators	104

### List of Figures and Tables

Table 1.1 – Generic physical supply and use tables	21
Table 3.1 – Flows covered by National Material Flow Accounts	28
Table 3.2 & Table 3.3: Example use and supply tables dealing with the socio-economic-system-as-a-black-box	37
Table 3.4: Example PIOTs describing the relationships between the environment and the material transformation and accumulation subsystems of the socio-economic system	42
Table 3.5 & Table 3.6: Physical Use and Supply tables, with the stocks of the socio-economic system distinct from transformation activities	43
Table 3.7: Example aggregate summary PIOT with net products' use by accumulation and details by kind of material	46
Table 3.8: Example PIOT for products with the activities of the socio-economic system subdivided according to economic and material categories and with inventories as net uses	52
Table 3.9: Example PIOT for residuals with activities of the socio-economic system subdivided according to economic and material categories	52
Table 3.10: Example aggregate summary PIOT with activities of the socio-economic system subdivided according to economic and material categories, net products' uses by accumulation and details by kind of material	54
Table 3.11: Example material use table with activities of the socio-economic system subdivided according to economic and physical categories and net changes for inventories	55
Table 3.12: Example material supply table with activities of the socio-economic system subdivided according to economic and physical categories	56
Table 3.13: Example PIOT for products with detail of flows by industry	61
Table 3.14: Example PIOT for residuals with detail of flows by industry	61
Table 3.15: Example material use table with detail of flows by industry	64
Table 3.16: Example material supply table with detail of flows by industry	65
Table 3.17: Complete example use table	70
Table 3.18: Complete example supply table	71
Table 3.19: Complete example aggregate PIOT	72
Table 3.20: Exemplification of the full PIOT for a specific material transformation chain	74
Table 5.1: Use table corresponding to the EW-MFAcc of a national socio-economic system (with flows of products of stocks as net flows)	90
Table 5.2: Supply table corresponding to the EW-MFAcc of a national socio-economic system	91
Table 5.3: Classification of material inputs	97
Table 5.4: Classification of material outputs	98
Table 5.5: Classification of material stock changes	98
Table 5.6: Reconciliation Table	105



“Onore al piccone e ai suoi più moderni equivalenti: essi sono tuttora i più importanti intermediari nel millenario dialogo fra gli elementi e l’uomo”

Primo Levi, *Il sistema periodico*, Carbonio<sup>3</sup>

## INTRODUCTORY NOTE

This report is part of a series of guidance documents that have been drafted in a joint effort by a group of experts from OECD countries led by the OECD Secretariat<sup>4</sup>. It benefited from contributions by members of the OECD Working Group on Environmental Information and Outlooks, the Eurostat Task Force on Material Flows, and the London Group on Environmental Accounting.

It draws heavily on the *Handbook on national accounting - Integrated Environmental and Economic Accounting* (the SEEA handbook)<sup>5</sup>, developed jointly by the United Nations, the European Commission, the IMF, the OECD, and the World Bank, and that is currently being revised; and on the methodological guide published by Eurostat in 2001<sup>6</sup>. It has been further developed in co-operation with Eurostat and in consultation with the UNSD and its Committee of Experts on Integrated Environmental Economic Accounting (UNCEEA).

It is to be seen as work in progress that will evolve as ongoing efforts on methodologies, definitions and classifications will show results, and as work on the SEEA led by the UNCEEA will progress.

### Purpose and scope

This document provides a theoretical and technical description of the concepts and principles of Material Flow Accounting (MFAcc) and of their application at the national level. It is designed to be used by an expert audience (material flow experts, statisticians, national and environmental accountants, researchers). It is not meant to innovate with respect to the existing measurement tools belonging to the MFA family nor to be prescriptive in promoting a particular tool in this family. The purpose is to:

- Provide a coherent theoretical framework that links the concepts of system analysis and integrated environmental economic accounting and that could be applied to the different accounting tools of the MFA family whatever their level of aggregation or application is, making their mutual relationships explicit, and acknowledging that each of these tools has its own meaning and usefulness.
- Promote the harmonised and integrated development of national material flow accounts by building on the SEEA handbook and recommending the use of physical supply-use and input-output tables as a general accounting/bookkeeping framework, that could be equally applied in applications based on the material balance logic in which it is not currently used (e.g. in Substance Flow Accounting).

<sup>3</sup> “All honor to the pickax and its modern equivalents: they are still the most important intermediaries in the millennial dialogue between the elements and man.”, translation from P. Levi (1984), *The Periodic Table*, 1st American Edition. Schocken Books, New York, NY.

<sup>4</sup> Document drafted by Aldo Femia (ISTAT, Italy) with inputs from Heinz Schandl (IFF-Vienna, Austria), Karl Schoer (DESTATIS, Germany), Ole Gravgard Pedersen (Statistics Denmark) and members of the Eurostat Task Force on Material Flows.

<sup>5</sup> United Nations, European Commission, International Monetary Fund, Organisation for Economic co-operation and Development and World Bank (2003), *Handbook of National Accounting – Integrated Environmental and Economic Accounting 2003*.

<sup>6</sup> Eurostat (2001), *Economy-wide material flow accounts and derived indicators – A methodological guide*. European Communities, Luxembourg.

- Describe how this general accounting framework can be applied at the national level to construct step-by-step a comprehensive system of material flow accounts, including relevant disaggregations by economic activity sectors.
- Discuss Economy-wide MFAcc, which is among the most common applications of MFAcc at the national level, show its relation to the general framework by highlighting the extensions and reductions of the observation field it introduces, and presenting bridge tables to allow reconciliation with the general accounting framework.

## Structure

Chapter 1 describes a general conceptual and methodological framework valid for the accounting of material flows of any kind of entity and at all aggregation levels, encompassing all MFA tools described in the first volume of the OECD guidance documents "Measuring material flows and resource productivity – The OECD guide. It proposes Physical Supply, Use and Input-output tables (PSUTs and PIOTs) as a general accounting/bookkeeping framework. This framework could equally be applied to other MFA tools that are based on the material balance principle but that currently do not use SEEA coherent methods (e.g. Substance Flow Accounting).

It then focuses on the application of these concepts and principles at the national level (Chapter 2 to Chapter 5), starting with some general remarks (Chapter 2).

- ◆ Chapter 3 introduces a theoretically sound and SNA-coherent scheme, with which all partial or aggregate applications should be coherent or with respect to which – in case departure from coherence be felt as necessary – differences should be declared. This ideal scheme is set up gradually, building up it step-by-step from the aggregate to the detailed, and forms in the end a comprehensive and detailed national material flow accounting scheme. Sample tables – progressively more complex and complete – are widely used in this chapter, describing the system at various disaggregation levels. This general accounting framework for NMFAcc is developed in full coherence with the System of National Accounts (SNA). The relationship between NMFAcc and monetary National Accounts is clarified in order to allow correct comparison between material flow and monetary data.
- ◆ The document subsequently dwells upon a quite widespread form of partial implementation of the complete accounting scheme, namely NAMEA-like tables (Chapter 4), discussing their advantages with respect to the full-fledged PIOT. This kind of application, while being partial, allows bringing in a richness of detail in terms of environmentally and economically relevant disaggregations of the flows, which is not possible in more complete applications.
- ◆ The document finally discusses Economy-wide MFAcc (Chapter 5), which is the most common application of MFAcc at the national level. It shows its relation to the ideal framework, highlighting the deviations from full coherence with the SNA in terms of the extensions and reductions of the observation field it introduces, and presenting bridge tables to allow reconciliation of this scheme with the ideal one, by extending the examples of Chapter 3. This kind of application, while being highly aggregate by activity, allows keeping both completeness and high level of detail by material as for the coverage of the flows crossing the boundary between nature and the socio-economic system.

The present document has a didactical intent, though the matter remains a non trivial one and is dealt with at a theoretical and conceptual rather than a practical level. Though directed to would-be practitioners of MFAcc it is therefore not meant to guide in the practical implementation of any particular MFAcc scheme. This is the purpose of a separate implementation guide that is being prepared jointly with Eurostat as the third volume of the guidance documents.

## Development process

Earlier drafts and elements of this document were discussed by the OECD Working Group on Environmental Information and Outlooks (WGEIO, Vienna, October 2006), the London Group on Environmental Accounting (New York, June 2006; Johannesburg, March 2007; Rome, November 2007), and the Eurostat Task Force on Material Flows (Luxembourg, December 2006, November 2007).

Its development has further benefited from a sequence of OECD workshops hosted by member countries (Helsinki, June 2004; Berlin, May 2005; Rome, May 2006), that brought together environmental administrations, statistical services, material flow experts and researchers, and from comments provided by MFA experts via an OECD electronic discussion group (EDG).

This document is to be seen as work in progress that will evolve as ongoing efforts on methodologies, definitions and classifications will show results, and as work on the revision of the SEEA led by the UNCEEA will progress. It has not been designed to become a statistical standard. The spirit is rather to provide elements of guidance to countries and to contribute to the SEEA revision by providing a basis for discussion and further development and methodological work.

## Outstanding methodological issues

There are a few methodological issues that are being debated as part of the revision of the SEEA and that might lead to further developments in the accounting framework presented here. Beside a few terminology questions, they concern mainly the further integration of Economy-wide MFAcc in the SEEA accounting framework and the establishment of an international consensus on the system boundaries to be used. Among these are:

### The residence versus the territory principle

Economy-wide MFAcc have been constructed according to the territory principle, as are environment and energy statistics (i.e. they account for activities on the national territory), whereas national accounts and the SEEA recommend the use of the residence principle (i.e. they account for activities of resident economic units).

The difference between the two principles relates mainly to international transport (goods and persons) of domestic economic units, and to the associated environmental and energy implications (energy use and air emissions from ships and air planes). This should not be seen as a major obstacle, but may raise interpretation issues when the results are communicated in the form of indicators or when they are related to economic indicators. More needs to be done to better understand to what extent the difference between the residence and the territory principle affects the results from economy-wide MFAcc and for which countries this difference is highest.

### The treatment of semi-natural systems: cultivated crops and trees

In the SNA, the growth of crops and trees, which is organized, managed and controlled by institutional units is a production process in the economic sense. In the physical accounts of the SEEA the inputs to that type of production process are (i) produced inputs (like energy, fertilizers, irrigation water) and (ii) ecosystem inputs (carbon dioxide, nutrients and non produced water) on the other ("eco-system-input approach"). The outputs are the products including the net change of inventories of non harvested products ("production approach") and the residuals generated by that production process.

In economy wide MFAcc the harvest of cultivated crops and cultivated trees is regarded as an extraction of biotic raw materials from the environment. Thus the borderline between the nature and the economy is defined by the harvest of the finished crops, felling of trees and uptake of

plants by animals through grazing ("harvest approach"). The produced inputs of seed, fertilizers and pesticides and irrigation water for cultivating the crops and trees, which in reality are at least partly incorporated into the plants, are fully regarded as dissipative output to the environment in order to avoid double counting. No eco-system inputs (e.g. water) to animal or crop production are accounted for.

*Chapter 1.***GENERAL CONCEPTUAL AND METHODOLOGICAL FRAMEWORK**

The present chapter provides the basic concepts and principles of all MF accounts. These concepts and principles are at the basis of the description of the material metabolism of all kinds of entities. They are introduced in the present chapter without reference to any particular entity or material and they may be used for all kinds of MFAcc described in volume I of the guidance documents.

Though the present volume is developed to support the description of socio-economic<sup>7</sup> material flows its basic concepts and principles can equally be applied to other entities, e.g. to ecosystems or territorial entities defined in purely geographical terms. They can also be applied to study the life-cycle of any kind of material and can be applied at any level of detail (e.g. in geographical or political terms). In order to underline their generality in the present chapter we will not necessarily use examples drawn from the functioning of the socio-economic system. In Chapter 3, however, they will be applied to the national socio-economic system and further specified, in order to adapt them and their exemplification to the description of this specific system's metabolism.

**1. BASIC CONCEPTS AND PRINCIPLES****1.1. Materials and activities**

The term "materials" is used here to designate all material things, at whatever level of specificity or aggregation they may be considered and dealt with in a physical accounting scheme, i.e. from the individual chemical elements to the overall material throughput of the focus system. Different individual materials and kinds of materials may be identified as being relevant in view of the purposes of the analysis, i.e. different classifications of materials may be relevant in different contexts. The materials may be the subject of an MFAcc individually or collectively, jointly or distinctly. The coverage of materials in an MFAcc may be complete or only concern specific materials or sets of materials (e.g. those causing a specific environmental degradation phenomenon or those for which there are supply security concerns or those involved in the metabolism of a living entity).

The term "activity" is used here to designate any natural process or human action that immediately implies a change in the physical status (location or composition) of some matter. Different kinds of activities may be identified as being relevant in view of the purposes of the analysis (e.g. human activities vs. natural processes, economic vs. non-economic activities among the former, and industrial vs. non-industrial activities among the economic ones) and be dealt with individually or collectively, jointly or distinctly. The coverage of activities in an MFAcc may be exhaustive or only concern specific activities or sets of activities (e.g. human consumption activities only).

The same matter usually appears in different forms and with different roles at different stages of its lifetime and is embodied in several different materials at different times, according to the different

<sup>7</sup> The term socio-economic system is used here to reflect the holistic nature of the concepts underlying material flow analysis. For most MF accounts it is understood to designate the economy and the economic system as defined in integrated environmental economic accounting.

activities in which it is involved, its provenience and destination, etc. e.g. the same atom of carbon may first be trapped in limestone, then, roasted, emitted as CO<sub>2</sub>, then linked by photosynthesis with other similar atoms in a glucose molecule then again burnt to CO<sub>2</sub>, etc. According to their varying nature, materials and material flows take different names, and specialised terms fitting the specific aims of the analysis are used in different contexts. In the following the most general kinds of flows will be identified and the corresponding terms adopted for general use.

## 1.2. Systems and subsystems

The material world is a unitary entity. However, in order to be able to describe and understand its functioning, it is useful to divide it into parts, which we will call systems. In this manual we will refer to systems that are distinct and non-overlapping parts of the world, even though such neat separations are sometimes quite arbitrary<sup>8</sup>.

MFAcc usually focuses on the physical functioning of one system. The focus system has to be carefully defined and identified from the rest of the physical world. The focus system and its identification and delimitation depend on the issues to be addressed and on the available knowledge and policy instruments. As clarified in volume I, different MFA tools focus on different systems, that are defined at various levels of aggregation and specificity, by material and by activity.

If the aim of an MFAcc is to describe the circulation of materials inside the focus system it is necessary to differentiate its activities, in order to be able to "capture" the materials as they pass from one activity to another; it may also be useful to define the relevant subsystems, i.e. the subsets of its activities and stocks that are of special interest for the analysis. Subsystems will be defined here as distinct, non-overlapping and jointly exhaustive parts of the system they belong to.

The concepts introduced in the present chapter have a degree of generality that makes them suitable for describing the material flows of any subsystem of the socio-economic system as well as of any other system. In Chapter 3, however, systems and subsystems will be identified by combining the physical concepts presented in the present chapter with National Accounting concepts. The use of the latter allows maximising the usefulness of MFAcc in relation to many of the objectives and uses discussed in volume I, especially of those MFAcc that describe the material flows of whole national socio-economic systems, be this description partial or total, aggregated or disaggregated.

## 1.3. Flows and stocks

In MFAcc the term flow is used to identify and describe the exchanges of materials between and within activities, systems or subsystems. Flows are measured with reference to the accounting period. The set of flows of a system are also called its material metabolism.

Given a well defined accounting period (usually a calendar year) the stocks of a system may be defined as materials that do not leave the system within the same accounting period in which they enter it. Stocks are measured with reference to a point in time, e.g. the beginning or the end of accounting period.

Stocks result from the net accumulation of prior flows, and they may be changed by the flows of the current accounting period. Some activities carry out accumulation functions (thereby comprising negative accumulation, i.e. subtraction from stocks). However, the materials are accumulated through them in the systems and subsystems and not in the activities themselves. As a consequence, activities as such do not have stocks and are only characterised by their flows. For simplicity, we will assume

---

<sup>8</sup> In principle, subdivisions based on fuzzy set theory (e.g. for activities which are not entirely dominated by human action nor entirely dominated by natural forces) could be also adopted, but this is not the case here.

that the accumulation functions are carried out by specialised activities only<sup>9</sup>, and therefore distinguish transformation activities from accumulation activities.

## 2. INTERNAL, CROSS-BOUNDARY AND EXTERNAL FLOWS

The internal flows of an entity (activity, system or sub-system) are flows which do not involve other entities. The exchanges of a given entity with other entities are its cross-boundary flows. Exchanges between two different activities or subsystems belonging to a same system are cross-boundary for the activity but internal for the system to which they belong. Exchanges not involving a given activity, system or subsystem are external to it.

Internal flows of the individual activities can be reported in an MFAcc only to the extent that the basic data refer to smaller components, which we will call "units" (e.g. data on the internal flows of an economic sector can be reported only if information is available on the exchanges between the different units belonging to it).

### 2.1. System boundaries

A material system can be thought of as a collection of stocks and activities which respectively belong to and are carried out in it. When a system is identified, a boundary is defined between it and its outer world. Given a well-defined boundary between two systems, the material stocks belonging to each of them are distinguished, and the material flows between the systems are identified (cross-boundary flows).

A collective characterisation of the cross-boundary flows allowing to identify the materials entering or leaving the focus system (e.g. "materials entering/leaving the system are all those absorbed/released by plants") is equivalent (dual) to the definition of the boundary itself, as also is the complete enumeration of the cross-boundary flows. In other words the flows identified as cross-boundary flows implicitly define the boundary and vice versa. E.g. if the flows of nutrients from the soil to a plant are defined as cross-boundary flows from system A to system B, then the boundary is where the roots meet the soil; equivalently the same boundary is defined by saying that the soil and its nutrients belong to system A while that the plant itself is a stock of system B. If on the contrary this flow of nutrients is not defined as a cross-boundary flow, then the soil and the plant belong to the same system and the flow is an internal flow of one of the two systems (may be either A or B; additional information on the boundary between the two is necessary to know each one).

The focus system of an MFAcc may also be defined on the basis of a set of materials, e.g. as the set of all the activities that exchange, accumulate or transform a given substance. The accounts may include all materials involved in these activities or only the materials of interest.

### 2.2. Open and closed material systems

Material flows that cross system boundaries create connections between systems. An open material system exchanges materials with its outer world. A closed material system, on the contrary, is a system that has no cross-boundary flows. For example, the economic system is open towards the rest of society, to which it supplies goods and from which it takes waste for management; the union of these two (sub)systems – i.e. the socio-economic system – is open towards the natural system, seems it takes resources from it and gives residuals back to it; the union of the latter two is clearly a

<sup>9</sup> Conceptually, it is always possible to distinguish the accumulation aspect and to deal with it as with a different activity.

closed system, as it encompasses everything that is material. Certain accounting identities hold for closed systems that are not valid for open ones.

It is always possible to deal with the focus system as with a subsystem of a wider closed system. No additional information is necessary for this if the accounts describe all the exchanges of the focus system with its outside world, which is usually the case. This allows to make reference in the accounting to the identities that are valid for closed systems. This can be done by explicitly including in the accounting scheme entries for all the systems with which the focus system exchanges materials, though limiting the description of the flows of these other systems to the materials that they exchange with the focus system.

### 2.3. Material inputs and outputs

One general characteristic of all material flows is that they have well-defined directions relatively to the activities, systems and subsystems that exchange the materials. A flow entering an activity or a system or a subsystem is called a material input to them and a flow exiting them a material output from them. An input is a use and an output is a supply of the activity or the system or subsystem.

The concept of flow entering (input) or leaving (output) an entity may be ambiguous, as it depends on the way the entity is looked at, and in particular on whether it is considered:

- As an aggregated black box;
- As the result of the juxtaposition of several smaller entities.

In the black-box case inputs and outputs are only the exchanges of the entity with the outer world, i.e. its cross-boundary flows. In the second case one may want to refer either only to the cross-boundary flows of the entity or to all the inputs and outputs of the smaller entities composing it, including the flows that are internal flows of the entity as a whole. This has also consequences for the measure of total flows of the systems and subsystems (see section 6 of the present chapter). Therefore it is recommendable to always specify whether these internal flows are included among the inputs and outputs or not.

Material flows are also connected in sequences chronologically and causally ordered, which must be considered in order to identify consistent system boundaries. E.g. if the branches cut from a plant are considered as an input from system A to system B, the flow of nutrients from the soil to the plant is an internal flow of system A, and the parts of the plant which are not cut continue to belong to this system.

## 3. CATEGORIES OF FLOWS

### 3.1. Used and unused materials

Materials that are not inputs to the focus system (i.e. are not taken into it and do not cross its boundary) are left unused in its outer world. Besides actually using materials in order to transform them and obtain other materials, however, the focus system (its activities) may simply displace materials that are outside of it, without taking them into it. As an example, let us consider an ant community building its underground galleries: the soil dug is not used by the ants, it is simply removed. Its flow is nevertheless immediately due to ant activity and it may be meaningful to record it in a material flow account of the "ant community" system. Though these unused materials do not physically enter in the activity that moves them (i.e. as neither inputs nor outputs), it is convenient, if the purposes of the account require keeping track of them, to record them both on the input and on

the output side of the activity's MFAcc, i.e. to deal with them as if they were materials that enter the activity as inputs and immediately leave it as outputs without having been transformed, differently from used materials.

### 3.2. Direct and indirect flows

The direct flows of an activity (or system or subsystem) are its immediate inputs and outputs as well as the unused material flows it immediately causes. The flows included in an MFAcc are usually limited to the direct flows of the focus system, namely its cross-boundary flows and some of its internal flows. It may be necessary, however, for the purposes of an account to refer to a broader concept of "material flows of a system" in order to cover all flows necessary to that system's activities by including some flows which take place outside the focus system but are "indirectly due" to it.

The concept of indirect flows is an analytical concept and not an accounting concept in the strict meaning of the term. Indeed, it is based on the idea that there are precise aims and final reasons for the material flows, and that these aims and reasons are in the achievement of some particular states of the matter or the realisation of some particular activities. These are not objectively identifiable in a purely descriptive system such as an MFAcc. On the contrary their identification usually precedes and conditions the building of the accounting system. In most cases this conditioning is limited to the way the focus system is disaggregated into activities and subsystems, but may also entail the explicit inclusion of indirect flows in the accounting schemes, following the definition of "indirect" most suited to the purposes of the analysis.

The concept of indirect flows of an activity may refer to inputs, outputs and unused flows. It makes reference to a functionally ordered chain of activities leading to that particular activity. Generally speaking, the indirect material flows of an activity are the materials that have been used or moved system-wide in order to realise its (material and non-material) inputs, but are not embodied in these inputs. They can be distinguished into those that crossed the system boundary (used indirect flows) and those that did not (unused indirect flows). Though in principle it may be referred to all the flows connected to "upstream" activities, at all stages of the chain, it is used usually to indicate only the flows that take place at the system boundary. In this case, the same matter is not included more than once in the indirect flows of an activity.

By extension, indirect flows are often attributed to some of the outputs of an activity, which are considered to be the aim and purpose of the activity itself. This typically is referred to the useful or desired results of human activities, i.e. to the material and immaterial products of economic activities (i.e. both goods and services) as well as to the needs satisfied as a result of final consumption activities (e.g. to calculate the Material Intensity per Service Unit, MIPS). Their indirect flows are the materials that have not been embodied in them but have been used or moved system-wide in order to obtain these outputs – i.e. to enable the activity that provides them – including what ends up in the other outputs of the activity, which are considered unwanted, but unavoidable, by-products.

## 4. THE LAW OF CONSERVATION OF MATTER AND THE MASS BALANCE PRINCIPLE

One basic feature of material flow accounting is the attempt to reach balance by integrating the input side, the output side and the net additions to the stocks in order to describe the material metabolism of human and natural systems. This is done by exploiting the identities provided by the application of the law of conservation of matter to activities, systems and subsystems. According to this law – as formulated by Lomonosov and Lavoisier in the XVIII century – matter is neither created nor destroyed in any natural process or human action. MFAcc is based on the application of the consequent mass or material balance principle. Though we know (from Einstein's special relativity) that a tiny portion of

matter is transformed in energy in some activities, this quantity is so small that for the purposes of material flow accounting it is sufficient to consider matter only and to measure everything in mass units. The supply-use, input-output and material accumulation algebraic identities that derive from the law of matter conservation are at the basis of all MFAcc schemes.

#### **4.1. Supply-use, input-output and material accumulation identities**

Supply-use identities: since an input of an activity or of a system is always necessarily an output of another activity or of another system, and an the output of an activity or of a system is always necessarily an input of another activity or of another system, the quantities of a given material made available (supplied) and those absorbed (used) by all activities and systems are identical.

Material accumulation identities: another consequence of matter conservation is that the quantity of materials accumulated by an activity, or in a system, in a given period – defined as the difference between the mass of its final and its initial total stocks – is equal to the difference between the inputs and the outputs of that activity, or system, during that period. Moreover, the quantity of the materials accumulated in a system is necessarily the same as that of the materials subtracted from all other systems (the accumulated materials may however be of a totally different kind of the subtracted ones, as a consequence of the physical transformations taking place in the activities; e.g. oil may be subtracted from natural reserves and plastics accumulated in the socio-economic system). A corollary of this is that in a closed system, there can be no net formation of stocks: its stocks may be transformed and may shift between subsystems, but on the whole the total stocks of the system remain unchanged, e.g. the quantity of materials accumulated by ants is equal to that subtracted by them to the environment.

The identity between the quantities of materials accumulated in the stocks of a system and those subtracted to the stocks of all other systems is also applicable at the level of the individual materials when these are not transformed into different materials in the activities but only flow between them (e.g. potassium atoms: their total number remains constant, and therefore so much potassium is accumulated in a system as is subtracted from all other systems). More in general, this identity holds for all quantities to which a conservation law applies. In all other cases, e.g. for materials that are transformed in the activities (e.g. chemical compounds that are broken and recomposed in different substances), the materials accumulated in a system will be qualitatively different from those subtracted from the others, though the quantities must match.

Input-output identities: for transformation activities the material accumulation identity boils down to an identity between the total mass of the inputs and the total mass of the outputs: indeed by definition these activities do not carry out any accumulation function, and all that goes into them must also leave them within the accounting period.

Yet another consequence of the law of mass conservation is that the total quantity of all the indirect inputs of an activity and the total quantity of its indirect outputs are identical. Indeed, if the indirect inputs have not been passed on to the next activity in the chain (i.e. embodied in the product for whose realisation they have been used) they must have been embodied in some other output and vice versa.

#### **4.2. The different meaning of the balancing for materials and transformation activities**

The material balance has very different contents and meaning depending on whether it concerns the flows of a specific material (e.g. lead, wood, etc.) the flows of a transformation activity (or of a system containing at least one such activity; e.g. a national economy).

In the first case the two sides of the account refer to a homogeneous, non-transformed item, as both contain data on one and the same material. The account only captures the two different aspects or sides of the same flows, i.e. the supply and the use of this homogeneous item. The only difference between the data on the two sides is in the distribution of the total quantity, broken down by supplying activities and by using activities respectively. Aggregation on each side, and comparison between the two, is intrinsically non-problematic as there is only one homogeneous material involved. This is a supply-use identity and is analogous to the economic notion that the effective demand for a product sold and bought on a market is identical to its supply (market-clearing condition).

In the second case the materials appearing on one side of the account are physically different from those appearing on the other side, as the balance refers to a transformation process in which the outputs are the joint result of the inputs' combination. Moreover, the materials entering the activity (input side) are usually not homogeneous among them, nor are the ones exiting from the activity (output side). The formulation of this kind of balance requires that the flows of the different materials be measured in homogenous units expressing invariant quantities. Moreover, it requires that these non homogeneous materials, thus measured, be summed together, on the input and on the output side, so that they can be compared and the existence of the balance verified. The case of the balance for a system where both transformation and accumulation activities take place is fully analogous, only also the changes in stocks have to be considered. The input-output identity is analogous to the economic notion of product-exhaustion for an economic production activity.

## 5. REPRESENTATION OF MATERIAL FLOWS THROUGH PHYSICAL SUPPLY-USE AND INPUT-OUTPUT TABLES

The general representation scheme adopted here is that of physical supply-use tables (PSUTs) and physical input output tables (PIOTs). These are analogous to the supply-use and input-output tables defined in the SNA (ch. XV) but they are not necessarily limited to economic products, as the range of materials covered by PSUTs and PIOTs is usually broadened in order to describe also flows that do not immediately correspond to economic value flows. On the other hand, PSUTs and PIOTs do not cover immaterial flows (such as e.g. financial flows) and therefore do not cover activities that do not involve materials directly.

The quantities reported in PSUTs and PIOTs may represent the actual mass of the materials themselves, or be referred to some specific chemical element or substance contained in the material. The identities discussed in the following are valid for whatever measure of the matter concerned may be included in the tables, provided that is subject to a conservation law such as that to which matter as a whole is subject. In particular, it may be useful to construct tables referred to the flows of a specific chemical element (e.g. mercury) that may be contained in different materials at different stages of its life cycle. These flows may equally well be measured as number of atoms or as mass of that element, as both do not change in the activities described<sup>10</sup>.

### 5.1. Physical supply-use tables (PSUTs)

PSUTs have two dimensions for the specification of the flows: one for the different materials observed and the other for the different activities covered. They show in mass units the quantities of the different materials made available (supplied) and the quantities absorbed (used) by the different activities. Such tables mainly differ in the meaning of the data reported: the supply table shows for each activity and material the quantities made available by that activity of that material, while the use table shows for each activity and material the quantities absorbed of that material by that activity.

<sup>10</sup> Remember that nuclear transformation has been excluded at the outset from our observation field.

Material supply-use tables usually focus on the description of the flows of a given system (the focus system) which is at the centre of the attention. However, in order to represent the exchanges of the focus system with other systems it is necessary to include rows and columns for activities that do not belong to it but supply and/or use materials that are used or supplied by the focus system. If rows and columns are included for all relevant external activities the representation is equivalent to that of a closed system of which the focus system is in fact a subsystem. In the simplest case, all relevant external activities can be collected in a single heading of the supply and use tables, entitled to all that is outside the focus system. However, this will not allow the analysis of the distribution of the cross-boundary flows according to the external entities that supply or absorb the materials, nor of the possible effects on the various components of the outside world.

In the following we will make reference to supply and use tables with the materials specified and detailed in the rows and the activities specified and detailed in the columns. At the bottom of the use table, we will record the difference of the total uses and supplies by activity (i.e. between each activity's total inputs and its total outputs), which gives the total net accumulation of materials in the activity. The tables are otherwise formally identical, although they show different things. In PSUTs that give complete and exhaustive coverage of a closed system's material flows and activities, the identities provided by the law of matter conservation and the material balance principle can be thus expressed:

- For the generic material  $i$  the sum of all cells of the  $i$ -th row of the supply table must be identical to the sum of all cells of the  $i$ -th row of the use table (total supply of the  $i$ -th material equal to its total use)
- For the generic transformation activity  $j$ , the sum of all cells of the  $j$ -th column of the use table must be identical to the sum of the  $j$ -th column of the supply table (total input of the  $j$ -th activity equal to its total output)
- For the generic accumulation activity  $k$ , the net accumulation (difference between the total of the  $k$ -th column of the use table and the total of the  $k$ -th column of the supply table, i.e. total input minus total output of the  $k$ -th activity) must be identical to the opposite of the net accumulations of all other accumulation activities. Indeed, in a closed system the total accumulation must be null, i.e. the net accumulations of the different activities must compensate each other.

Table 1.1 provides a view of the theoretical tables for such a complete closed system.

**Table 1.1 – Generic physical supply and use tables**

USE TABLE		ACTIVITIES										TOTAL USE BY MATERIAL	
		Transformation					Accumulation						
		1	2	...	<i>j</i>	...	...	<i>k</i>	...	<i>m</i>			
MATERIALS	1												
	2												
	...												
	<i>i</i>												
	...												
	...												
	...												
	<i>n</i>												
	TOTAL INPUT BY ACTIVITY												
	Balance by activity (tot. input - tot. output = net accumulation)		0	0	0		0						0

SUPPLY TABLE		ACTIVITIES										TOTAL SUPPLY BY MATERIAL	
		Transformation					Accumulation						
		1	2	...	<i>j</i>	...	...	<i>k</i>	...	<i>m</i>			
MATERIALS	1												
	2												
	...												
	<i>i</i>												
	...												
	...												
	...												
	<i>n</i>												
	TOTAL OUTPUT BY ACTIVITY												

Material supply-use tables can in principle be applied at any level of material and activity detail, according to the objectives of the analysis. They can be applied also with any degree of material and activity coverage. However, the identities specified above will in general not be respected in an incomplete or non exhaustive PSUTs pair. Even in these cases, nevertheless, local completeness and/or exhaustiveness conditions may be respected. In particular:

- for the supply/use identity to be applicable to the data on the flows of a specific material, it is necessary and sufficient that the supply table cover the whole set of activities that supply it and that the use table cover the whole set of activities that use it. In this case, the total quantity of the material made available by all activities (reported on the right of the supply table) must be equal to the total quantity of the material absorbed by all activities (reported on the right of the corresponding row of the use table).
- for the input/output identity to be applicable to the data on the flows of a specific transformation activity, it is necessary that the use table cover the whole set of materials that are used or moved by the activity, and that the supply table cover the whole set of materials that the activity provides or moves. In this case, the total quantity of all materials made available by the activity (reported at the bottom of the supply table) must be equal to the total quantity of the materials absorbed by the activity (reported at the bottom of the corresponding column of the use table).

Neither global completeness nor global exhaustiveness are therefore necessary requirements for the construction of PSUTs. For instance, it is possible to construct them limiting attention to some materials and/or to a specific set of activities, for which one may then want to respect the balancing conditions, even with some approximation. As long as the possibility of reading them jointly by making reference to the balancing principles seen above is preserved, also partial PSUTs constitute an accounting system with a value added with respect to simple "material by activity" tables. Finally, it is always possible to complete a PSUTs structure by adding an "other materials" row entry as to make it complete by closing the system with the "rest of the world" activity column.

## 5.2. Physical input-output tables (PIOTs)

Also physical input output tables (PIOTs) have two dimensions for the specification of the flows: one for the activities in their material supplier's role and one for the (same) activities in their user's role. They represent the circulation of matter between the different activities, showing the direct exchanges of materials between them in a matrix form. Its rows show the quantities of materials provided by each activity while its columns show the quantities of materials absorbed by each activity.

If an accounting system has both PSUTs and PIOTs, the activity headings of the latter and even the criteria for the definition of the activities in the PIOT, need not necessarily be the same as in the corresponding PSUTs. However we will refer to a simple system where PIOT row and column headings are identical to and have the same meaning as the column headings of the PSUTs.

Differently from the PSUTs, in a PIOT representing all flows, these flows cannot be detailed according to the kind of material in PIOTs, since both dimensions of the table are already occupied by the activities. In order to encompass all flows, aggregation of the different materials is necessary. This necessarily results in a loss of information; this loss is compensated however by the possibility of knowing for each activity which activities supply materials to it and at the same time which activities use the materials it provides. This allows exploring the physical interrelations that directly link the activities and that are hidden behind the supply and use tables. Such knowledge is important e.g. for the analysis of indirect flows.

In order to reduce the loss of information due to aggregation, it is possible to construct partial PIOTs, concerning different materials or material groups. No information at all is lost with respect to PSUTs (on the contrary there is more) if different PIOTs are constructed for each of the different materials that appear in the supply and use tables. A complete and exhaustive representation scheme would ideally comprise an input-output table for each material. All these tables together would form a three-dimensional table, with a) supplying activities, b) using activities and c) materials in the three dimensions. (PSUTs would in this case be totally superfluous). However, this may not only be very difficult to realise but also it may be difficult to use information so detailed, since the system gets quickly very complex.

If a one-to-one correspondence exists between each of the individual activities and individual materials or material groups, i.e. specific materials or material groups univocally identify specific activities and vice versa, two of the three dimensions become interchangeable, and there is no need for a PIOT, as this would not provide additional information. E.g. if each activity only had one output, given by that activity alone, the use table would coincide with the PIOT, in the sense that it would suffice to substitute the names of the materials in the headings of its rows with the names of the unique activities that give them. In general however this is not the case and the PIOTs embodies additional information with respect to PSUTs. Its construction then requires the use of additional sources of information, or the reduction of the complexity by the adoption of ad hoc hypotheses on the relations between activities and materials. The latter is the usual way of construction of input-output tables, though not necessarily the only one.

In a PIOT the input-output identity for transformation activities is expressed as the identity between row and column totals: this is exactly the same input-output identity given by the identity of the

column totals of supply and use tables, and is therefore subject to exactly the same completeness condition, i.e. all the materials involved must be included in the table (even if they are not detailed by kind)<sup>11</sup>. Accumulation activities will show in PIOTs an imbalance between inputs and outputs exactly as in the totals of the supply-use column pairs entitled to them.

A PIOT for a single material or referred to a limited group of materials will generally not be balanced (i.e. a transformation activity's total inputs will not match its total outputs) and the extent of the imbalance (which may be recorded in an additional row or column) will depend on the extent to which the transformation activities use inputs and/or supply outputs that do not belong to the materials group. However, in a complete collection of non-overlapping and exhaustive PIOTs for a closed system, all the imbalances must compensate each other for each and every transformation activity, and also the total imbalance of all accumulation activities must be null.

## 6. INTERNAL FLOWS, AGGREGATION BY ACTIVITY AND THE MEASURE OF TOTAL FLOWS

The total flows of a system or subsystem are given by the sum of two types of flows:

- The flows between it and the other systems or subsystems (its cross-boundary flows)
- Its internal flows. These in turn may be distinguished into:
  - The flows between its individual activities (their cross-boundary flows that are internal for the system or subsystem);
  - The internal flows within each of its individual activities (their internal flows).

The measure of the total flows of a system or subsystem recorded in an accounting scheme is independent from its aggregation by material, but may be dependent on the aggregation by activity. It will be independent also from the latter only if its internal flows are included in a way that does not make their total measure change depending on the aggregation by activity. This is the case for instance when the flows of the individual activities are measured and reported with reference to smaller invariant individual units.

In the case that only the cross-boundary flows of the individual activities are reported in the accounts, the total flows recorded for the systems and subsystems to which they belong will vary according to the aggregation by activity of the account. In order to clarify this, let us make reference to two accounting schemes, representing the same situation at two different aggregation levels, so that one of the two encompasses the other, and that we do not report the internal flows of the specified activities in neither of the two. For instance, let the less detailed scheme be obtained by consolidating two activities of the more detailed one. Now, when this consolidation is done, the mutual exchanges of these two activities (assuming they are not null) will not be visible in the resulting scheme, as they are not cross-boundary flows anymore but internal flows of the new activity resulting from the consolidation. As such, they will not be reported, so that the total flows recorded in the less detailed scheme are lower than those recorded in the more detailed one. The total flows recorded in the two schemes will be the same if both schemes report the internal flows of their respective individual activities measured with reference to the same individual units.

The measure of an individual activity's internal flows heavily depends on the way these flows are measured, i.e. on the definition of its units, at the crossing of whose boundaries the flows are surveyed, while this is not the case for the flows between the activities.

<sup>11</sup> For all materials to be included, all activities of provenience and destination of these materials must be included, since in the PIOT the materials are detailed by activity of provenience/destination.

## 7. NET FLOWS AND AGGREGATION BY MATERIAL

Generally speaking, the net supply of a system is defined as its (gross) supply minus its use, and its net use is defined, in a mirroring way, as its (gross) use minus its supply. The net supply and use of materials of each of the activities, systems and sub-systems included in an accounting scheme can however be defined according to various perspectives. In particular, these concepts can be applied at various aggregation levels by material.

In an aggregate materials perspective, no distinction is made between the different materials or kinds of materials, so that all the material uses of an activity are summed together, and so are all its material supplies, before calculating its net material use or supply. In this case the net use flows of the systems coincide with their respective (net) aggregate material accumulations. Their net supply has the same absolute quantity but opposite signs.

In a homogeneous materials perspective materials are grouped according to some criteria and summed up together only when belonging to the same group. So there will be as many net uses and net supplies as many groups. Clearly, the breakdown by group may be pushed to whatever level is suited for the purposes of the analysis. It is important to notice that summing up the net uses or the net supplies by material kind one always gets the aggregate net use and net supply respectively.

The net supplies of an activity, system or subsystem can be calculated from the SUTs by subtracting the column entitled to it of the use table from the corresponding one of the supply table. Its net uses are the same but of opposite signs.

*Chapter 2.***CHARACTERISTICS OF NATIONAL MATERIAL FLOW ACCOUNTS (NMFACC)**

---

The present chapter highlights some characteristics of the applications of the concepts and principles introduced in the previous chapter to national socio-economic systems. These concepts (system boundaries, subsystems, kinds of materials, accounting treatment, etc.) are applied and further specified as necessary in sections from Chapter 3 to Chapter 5.

**1. COMPREHENSIVENESS, INTEGRATION BETWEEN LEVELS, COHERENCE WITH NATIONAL ACCOUNTS**

NMFACC form a multi-purpose multi-level system designed for the accounting of materials use in human activities. This system aims at providing a comprehensive framework for satellite accounts on material flows that can be applied at different levels, in terms of the range and detail level both of the activities and the materials covered.

Such a framework allows integrating the different levels of the analysis and encompassing them as special cases. For some special cases, the terminology and the classifications – but not the concepts, which are of general value – are further specified.

NMFACC are built largely in coherence to the SNA, though they deal with phenomena of a different nature from those described in the SNA. They belong to the kind of accounting frameworks linked to the System of National Accounts as satellite accounts that need to make use of additional concepts with respect to the monetary national accounts. Indeed NMFACC explore an aspect of the functioning of the socio-economic system that is not covered by the SNA.

NMFACC include definitions and rules covering as wide a range of circumstances as possible and can be applied to very different national systems, whether they are large or small, industrialized or developing, well endowed with natural resources or major importers of raw materials, etc..

The availability of NMFACC and of derived indicators is a prerequisite for informed policy making. NMFACC can be used for reporting MF data to international organisations in line with standard, internationally accepted concepts, definitions and classifications. They have also an important statistical function as they can serve as a framework for a substantial part of environmental statistics.

The limits of the available information oblige in certain cases to depart from full coherence with the SNA. This is the case in particular of the Economy-wide Material Flow Accounts described in Chapter 5. Even in this case, however, the basic structure of the system guarantees a high degree of comparability of MFA data with monetary aggregates.

## 2. QUALITY CRITERIA

### 2.1. Theoretical soundness

Like any complex accounting system, material flow accounting requires a guiding conceptual framework to ensure the consistency of the numerous methodological decisions to be made. This refers to the criterion of theoretical soundness, which is also a prerequisite for policy relevance. The basic concepts and principles have been presented in the previous chapter. The guiding theoretical concept for explaining the physical interrelation of a socio-economic system and nature is in particular that of socio-economic metabolism. Every socio-economic system organises a permanent flow of materials and energy, i.e. a metabolism, in order to reproduce biophysically. The socio-economic metabolism encompasses the extraction of materials from the environment, their transformation in the process of production, distribution and consumption and their eventual release to the environment. To be able to assess socio-economic metabolism we must gain a systematic view of the interaction between two systems, namely society and nature as well as possibly of the internal flows of the first. For this we need precise guidelines to identify, which elements of the material world belong to society and which belong to nature. That refers to a clear understanding and definition of the boundary of the system under investigation. In material flow analysis these requirements are made operational by applying a systems approach and natural science considerations.

The systems approach has so far been applied in a variety of disciplines. Biology, for example, conceives of an organism as an integrated entity composed of interdependent components such as organs or cells. Likewise, economics conceives of a national economy as an integrated system composed of interdependent parts. In both biology and economics the components are considered as entities operating their own metabolism or input/output relationships. According to this, the metabolism of socio-economic systems is composed of interdependent self-organising components that maintain their own metabolism rather than being just an assembly of material stocks and flows.

### 2.2. Policy relevance

The usefulness of material flow analysis for informing policy mainly derives from the conceptualisation upon which it is based, and that concerns the interrelation between socio-economic activities and the issues at stake (e.g. supply security and environmental degradation). The interrelationships between economic, social, political and environmental processes is highly complex and available information, judgement of experts and public awareness are often controversial or insufficient. The criterion of policy relevance refers to a well-chosen reduction of this complexity rather than to a full understanding. In other words, it refers to the capacity to provide relevant and useful information for decision making and public discourse. Therefore, the information must successfully reduce complexity and be timely. Only if this is achieved, material flow accounting can be a useful tool for providing information and support monitoring of the future sustainability of resource use. Other criteria for enhancing the policy relevance of the tool include coherence with the SNA, international comparability, the indication of major trends in the resource use of national socio-economic systems, the possibility of application for various levels of intervention, the possibility to arrive at time series and to assess scenarios, and the compatibility to established environmental information systems.

### 2.3. Feasibility

Finally, like any approach that addresses real world problems the criterion of feasibility has to apply. This refers to the availability of accurate primary data, the possibility to fill data gaps, and the timely availability of the accounts. To allow for this, some material flow accounts use a top-down approach based on data periodically available in national statistics to allow for data generation and indicator development in relative short time to reasonable costs, deviating from full coherence with the SNA for the sake of feasibility, timeliness and ease of communication. This is the case of Economy-wide MFAcc described in Chapter 5.

## Chapter 3.

# A COMPLETE AND EXHAUSTIVE FRAMEWORK FOR NMFACC

## 1. INTRODUCTION

### 1.1. Relation with the SEEA

In the present chapter we apply the concepts introduced in Chapter 1 to a specific system, i.e. to the national socio-economic system and develop an accounting scheme referred to it. This is done largely on the basis of the third chapter of the Integrated Environmental and Economic Accounting 2003 (SEEA2003) Handbook. The accounting framework we present here is basically the same as that contained in the SEEA, though it is amended and adapted on some points.

The major differences with the SEEA2003 are in the exposition method, as we set off with didactic intents. In particular, we build the complete accounting scheme step-by step rather than introducing it all at once. We do not take for granted but discuss the relation between the economic and material reality and specify the accounting scheme accordingly, in order to keep to a minimum the previous knowledge of National Accounting required to the reader. We do this by starting from a purely physical subdivision of the socio-economic system and introducing economic concepts in a second stage. This leads to the explicit discussion of the link between the flows of economic value and of materials, and to a partition of human activities that optimally combines physical and economic concepts. Moreover, a certain emphasis is put on the circulation of matter, as described by Physical Input Output Tables, since its understanding of key importance to resource management and environmental pressures prevention. PIOTs are widely used here as an exposition and exemplification tool, as they provide an in-depth description of the roles of the different socio-economic activities in the use of natural resources and products and in the generation of residuals.

### 1.2. Objectives

Society cannot function without drawing in natural resources from the environment and using the environment to absorb the unwanted by-products of economic production and of consumption. Measuring the flows of resources into the socio-economic system and the emissions from it can therefore provide instructive information. It can show, for example, whether the amount of material passing through the economy is increasing, and whether it is increasing faster than the rate of growth of the economy or whether it is increasing in per capita terms. This can be especially useful in the case of trying to minimise the generation of dangerous wastes.

The exhaustive and detailed measurement of the physical flows connected to human activities is a non-trivial task. It requires large amounts of basic data, consistent classifications and units of measure and an agreed framework within which data can be structured at different levels of disaggregation. It also requires an understanding of the purposes for which the resulting tables can be applied. All of these are topics for this chapter. Nevertheless we will mainly focus on the framework for structuring the data.

### 1.3. Specification of the focus flows

#### 1.3.1 Specification according to the systems involved

The flows of major interest in the present context can be identified by making reference to a condensed version of a comprehensive IO scheme anticipating the subdivision of the world that will be introduced later. The blank cells in Table 3.1 correspond to flows that are not meant to be covered at all in the scheme. The flows in brackets are minor quantities that may be relevant for the national environment, and may be easily included if the relevant additional information is available but are not relevant for our scopes, so we will not include them in our discussion. Basically, we are interested in the flows involving the national socio-economic system, most of which – though not all – are flows connected to economic activities.

The largest entries are in the parts of the table showing the interactions within the national socio-economic system, between it and the national environment and between it and the rest of the world socio-economic system.

**Table 3.1 – Flows covered by National Material Flow Accounts**

		To		From	
		Socio-economic system		Natural Environment	
		National	Rest of the world	National	Rest of the world
Socio-economic system	National	Internal flows of the national socio-economic system PRODUCTS RESIDUALS	Flows from the national socio-economic system to the rest of the world socio-economic system PRODUCTS RESIDUALS	Flows from the national socio-economic system to the national natural environment RESIDUALS	Flows from the national socio-economic system to the rest of the world natural environment RESIDUALS
	Rest of the world	Flows from the rest of the world socio-economic system to the national socio-economic system PRODUCTS RESIDUALS		(Flows from the rest of the world socio-economic system to the national natural environment RESIDUALS)	
Natural Environment	National	Flows from the national natural environment to the national socio-economic system NATURAL RESOURCES ECOSYSTEM INPUTS RESIDUALS	(Flows from the national natural environment to the rest of the world socio-economic system NATURAL RESOURCES ECOSYSTEM INPUTS)		(Flows from the national natural environment to the rest of the world natural environment RESIDUALS)
	Rest of the world	Flows from the rest of the world natural environment to the national socio-economic system NATURAL RESOURCES ECOSYSTEM INPUTS		(Flows from the rest of the world natural environment to the national natural environment RESIDUALS)	

#### 1.3.2 Specification according to the materials of interest

Materials, considered in general, are defined here in the same all-encompassing way as in chapter Chapter 1. The primary focus of the NMFacc framework presented here is on the flows of solid natural resources, including minerals and plants of all kinds. These flows are at the basis of the physical functioning of socio-economic systems, along with the use of air, water, energy and land.

The primary aim of the accounting framework is to support the measurement of resource use efficiency and the formulation of waste prevention strategies. These uses require the adoption of a system perspective. Therefore the focus materials are considered in a balanced and complete accounting framework, able to reflect the way the different materials are combined and transformed into goods, waste and emissions.

The focus materials are considered in the myriad of different forms that they take in the socio-economic process (e.g. ores, refined metals, food, buildings, pieces of furniture of plastics and wood, waste from all these). Hence, it is necessary – for the supply-use accounts of the activities to be well-defined and balanced – that also materials other than the focus resources are included in the accounts, namely all those materials with which the focus resources are combined in the socio-economic metabolism. We will also therefore consider all the products and wastes derived thereby.

In practice, as a consequence of the system approach, it is not possible *a-priori* to exclude any kind material from the accounting scheme. It is only possible to restrict the consideration of some materials to the extent needed for balancing reasons. In particular, this is the case of air and water, further discussed in subsection 2.2 of the present chapter. It should however be borne in mind that the focus of the accounting framework presented here, though potentially covering all materials, is mainly on those materials that are not covered by specialised accounting frameworks, such as e.g. water and energy accounts.

Although we will discuss the flows of materials moved by human activities having in mind the specified focus, it must be underlined that the accounting schemes presented below can be referred to specific sets of materials which are of particular interest. For example it is possible to focus on the supply and use tables for specific toxic chemicals or energy products and omit information of the flows of other materials. Further, the supply and use table for one or more materials can be transformed to supply and use tables for energy (calorific values) or chemical elements (nitrogen, say) by using technical information on the composition of the materials (for example, percentages of nitrogen on the mass of the different materials). Physical supply and use tables for energy products are interesting for the analysis of energy savings/efficiency analysis as well as for the construction of supply tables for energy related residuals, such as CO<sub>2</sub>, SO<sub>2</sub>, NO<sub>x</sub>, etc.

#### 1.4. Outline of the chapter

A stepwise approach is followed in the specification of the NMFAcc scheme, by progressively specifying the relevant systems and sub-systems. New elements are introduced in the scheme when they are first needed as to favour stepwise learning.

First of all we distinguish the socio-economic system as a whole from the natural environment as a whole, abstracting from all their possible further geographical, political or economic subdivisions (section 2). The flows that cross this boundary are caused by the socio-economic system and are pressures from it on the natural environment. The definition of this boundary is both necessary and sufficient for introducing most of the categories used in the subsequent more complete versions of the scheme, while keeping it as simple as possible. In particular, it is in relation to this boundary that the general categories of material flows are identified in the system.

The framework deals with the material flows which form the material metabolism of the socio-economic system, as this is the sphere where human actions have immediate effect and whose flows are more directly under the control of policy. As a consequence, the only activities of the natural environment we will consider are that of supplying useful materials and absorbing discarded ones. This will not change throughout the chapter but it should be kept in mind that the natural environment could be further specified according to many different criteria. We will start looking inside the socio-economic system by distinguishing only the very general activities of materials' transformation and accumulation in the first place (section 3). This will allow us to introduce other important concepts

such as that of gross and net flows, and some alternative ways to present the accounts according to whether certain flows are recorded gross or net.

Focussing on the national socio-economic system, the physical concepts of materials' transformation and accumulation, as distinguished before, are put in relation to the economic concepts of production, final consumption and accumulation (section 4). Subsequently, production is further split into smaller entities according to the kind of activity (section 5). These subsequent subdivisions of the national socio-economic system are of fundamental importance in order to understand how the material flows at the system boundary are determined by the activities taking place inside the socio-economic system and how they can be influenced by policy influencing these activities. The subdivision of production by sector will allow us to introduce the issue of indirect flows.

Finally, the distinction will be made between the national and foreign socio-economic and environmental systems (section 6). The *national* socio-economic system is the focus system of the scheme and only the flows that directly involve it will be described, while the flows within and between the other systems are beyond the scope of the NMFacc system (but for what concerns the issue of indirect flows).

This sequence of progressive subdivisions of the world is an exposition expedient allowing to introduce the necessary concepts and specifications stepwise as to make easier the learning of the system. It does not correspond to a sequence of practical steps for the implementation of a national material accounting scheme. Nor do any recommendation on which kind of disaggregation of the focus system to apply first. It should be borne in mind, moreover, that none but the last version of the schemes presented is complete with the rest of the world sector and therefore realistic.

While the following subsections aim to give a comprehensive overview of the functioning of a national socio-economic system by making use of sample material flow schemes, it should be recognised that a complete implementation of the accounting framework presented is very ambitious and by no means necessary for particular studies. The extent of implementation typically depends on (human, data and time) resource availability. In particular, most current applications are reflected by the schemes described in Chapter 5. These deal with the material flows of a national socio-economic system, described as black-box (Economy-wide MFA) or disaggregated by sector (NAMEA-like accounts of specific flows).

The figures presented in the tables shown in the following subsections are purely illustrative and relate to a fictional country. All these tables are internally and mutually consistent. All data are denominated in million metric tonnes though three decimal places are shown to illustrate the occurrence of small but possibly important entries at the thousand metric tonnes level.

## 2. DEALING WITH THE SOCIO-ECONOMIC SYSTEM AS A BLACK BOX

In the present subsection we define the system boundary dividing the socio-economic system from nature as if there was only a single country in the world. More precisely, we describe the material flows of a hypothetical single country placed into a huge glass bowl, which has no relation with the rest of the world but possibly through exchanges of electricity and other immaterial communication ways of any possible sort (from smoke signals to the Internet). This simplifying assumption will be kept throughout the following sections of the present chapter, up to section 6, where we will allow for other exchanges to take place.

## 2.1. System boundary

### 2.1.1 General criteria

The national socio-economic system can be defined, in very general terms, as the collection of activities taking place in a country that are under direct human control and responsibility (human activities). NMFAcc identifies the material elements that make up the physical components, i.e. the material stocks of the socio-economic system. Such stocks of materials are mainly man-made fixed assets as defined in the national accounts. In this understanding, every part of the material world that is produced, or is periodically maintained, by human labour constitutes a material stock of the socio-economic system. In this definition, the material stock of the socio-economic system includes infrastructure, such as buildings, roads, dams and sewers, vehicles, capital goods, consumer durables, inventories of products at all stages of production but also livestock and humans themselves<sup>12</sup>.

Once the stocks have been properly defined, every material that is used to produce or reproduce the stock is accounted for as a flow. A reliable distinction between stocks and flows is a prerequisite for determining whether the socio-economic system is growing in physical terms and at what speed or whether it is in a steady state or even shrinking. Accordingly, an operational distinction between size and metabolic rate, i.e. between the physical growth rate and the material turnover can be drawn. Clearly, there is a close link between stocks and flows and also a positive feedback. The size of the material stocks is a determinant of the size of the flow needed to reproduce the existing stock.

As far as flows are concerned, the boundary with nature is defined in functional terms, by the extraction of primary materials from the natural environment and the discharge of materials to the natural environment. With this boundary definition we identify what is a flow within nature (external to our focus system), within the socio-economic system (internal), from nature into the socio-economic system and back from the socio-economic system into nature (cross-boundary).

As a general principle, inputs from the environment to the socio-economic system are natural materials extracted on purpose by humans or by human-controlled processes, by means of technology (i.e., immediately involving labour) as well as by natural processes that incorporate matter into products as defined in the SNA (as in the case of cultivated plants). Outputs released to the environment are materials over whose location and composition society loses control.

The national accounts and the Pressure-State-Response framework offer useful guiding principles for the precise specification of the borderline between the socio-economic system and nature. In general, national MFAcc should be consistent with the national accounts; in particular, materials entering activities that are comprised in the SNA's production boundary are necessarily either internal flows of the socio-economic system or inputs from nature to the socio-economic system. Materials recorded as inputs or outputs belong to the Pressure category. In the following, several borderline cases are clarified.

## 2.2. Borderline cases

### 2.2.1 Air and water

Three main groups of materials may be distinguished, namely air, water and all the other materials. The heterogeneous group of the non-water non-air fraction includes the mineral and biological natural resources which are our main focus, as well as most of the material things in which they are transformed: raw materials, semi-manufactured products, final goods, pollutants emitted to air and water, waste, etc..

---

<sup>12</sup> We will not explicitly deal with humans as a stock; nevertheless they are part of the final consumption subsystem. Non-produced assets enter our field of observation only when used for current production: the acquisition of property rights over them does not entail the recording of physical flows.

It will be impossible to exclude air and water from our discussion altogether because the distinction between the three material groups does not hold perfectly on closer examination, since the non-water non-air fraction is not free of water and air. Moreover, the content of water and air of the various materials constantly changes due to natural processes (like evaporation, oxidation) and due to technical processes during the production-consumption-waste process. Water in particular is present as input or as output of processes involving the focus materials at all stages of transformation chains.

Air and water as such will therefore also be considered here, but only to the extent that they are incorporated into other relevant materials or cannot be distinguished from the materials with which it becomes mixed in human activities. (incorporation into products, humans, pets, home garden plants or residuals). Not reporting, as much as possible, air and water in EW-MFAcc accounts has to do with the common-sense idea of not literally "drowning" the other materials in water and air.

Inputs of the non-air-non-water fraction are counted when they cross the border into the socio-economic system under investigation, that is usually when they are marketed. Therefore, all inputs are accounted for as market weights, including their actual water and air content, with the important exception of grass harvest and timber, which is counted with standardised water content of 15%. Inputs that are not marketed such as green fodder grazed by cattle are also included in the accounting with standard water content of 15%.

Water used for irrigation (as well as rainwater) has to be recorded as an input of the socio-economic system only to the extent that it is absorbed and retained by cultivated plants. Also the water incorporated in industrial goods (such as e.g. paint) has to be accounted for, as it affects the mass of the derived products and wastes. On the contrary, water used for irrigation in excess of the amount absorbed by plants, for the cooling of industrial plants, for washing or cooking, for hydro-power, etc. is not recorded in the scheme. In some cases solid residuals from other used materials may be contained in water discarded to the environment; these have to be accounted for as outputs of the socio-economic system, but the water itself should not enter the account. Only in the cases where it is impossible to distinguish the water component from the rest, water may be comprised in the account, and care must be taken that the water included in the output item be also comprised in the inputs of the activity (e.g. water drunk by livestock has to be included among the inputs if manure is accounted in "as is" weight among the outputs). As a consequence water as such, in its liquid form, should not be a major output to the environment to be recorded in the accounts.

A great part of the water that is included as an input in the accounts according to the convention set above leaves the socio-economic system mainly as vapour, as a result of processes in which it is created, or driven out from materials in which is incorporated. In particular, vapour results from respiration of humans and livestock, from exsiccation of wood, roasting of minerals and similar processes as well as from the chemical combination of hydrogen contained in fuels and atmospheric oxygen in combustion processes. Water drunk and not absorbed constitute most of the remaining part.

### **2.2.2 Agricultural production, forestry and husbandry**

Unlike other purely technical processes of production, which are almost completely under human control, agricultural and forest production is mainly the result of biological metabolism, whereby the cultivated biological organisms interact more or less directly with the environmental sphere by extracting raw materials and by discharging residuals. However, according to the SNA production boundary, cultivated plants and cultivated animals are the results of production processes and have therefore to be regarded as belonging to the socio-economic system. Wild biota, i.e. uncultivated plants and animals, are on the contrary considered to be materials extracted from the environment.

Plants absorb directly from nature mainly carbon dioxide and water and convert this into oxygen and an increase in mass (which constitutes economic production in the case of cultivated assets). The increase in mass of the plants is accounted for mainly by the fixing of the carbon and the absorption of

water. Not all the water absorbed is retained, most is lost through evapotranspiration, but the net retention is still significant.

The fertiliser and pesticides spread on the land are defined as outputs to the environment only to the extent that they are not absorbed by cultivated plants. The absorbed portion constitutes an internal flow of the socio-economic system.

### **2.2.3 Solid waste**

Flows of solid waste are recorded in the accounting scheme as flows from the socio-economic system to nature only when waste is disposed of directly in nature, e.g. just thrown away in the woods or in uncontrolled landfills or in illegal dumping sites. On the contrary, waste going from industries and households to collection systems and treatment plants are considered internal flows of the socio-economic system. The incineration of waste is a transformation activity that results in an output of gases and dust to nature. The operation of managed landfill sites (strictly speaking licensed and controlled landfill sites) is a productive activity and the disposing of residuals at such sites is regarded as a flow of residuals within the socio-economic system and treated as a form of accumulation in this system. When materials subsequently evaporate or leak from such a site into the surrounding air, soil or water (including from managed sites where rigorous prevention measures are not in effect), a flow of residuals from the socio-economic system to the environment should be recorded.

### **2.2.4 In situ uses of environmental assets**

A number of environmental assets are only used *in situ* and not actually absorbed into the socio-economic system through use. For example, functions or services provided by the environment such as watercourses for navigation, land for transportation, land and water as a sink for pollution. In such cases it is the natural assets as such, rather than the materials, which are used: the natural assets provide services but there is no physical flow out of and into the environment, and therefore there is no entry for *in situ* uses in national MFAcc schemes.

### **2.2.5 Unused materials**

Unused flows are different from *in situ* uses as they concern materials rather than natural assets. Moreover, these materials are not used and they are physically removed from their natural site (no service is provided by them; on the contrary, their presence is usually a disturbance for the human activities that move them). As examples, let us consider the extraction of metal ores, the felling of timber in a non-cultivated forest, and the excavation of soil in construction. In order to extract metal ores, overburden has to be removed to retrieve the gross ore, which, after further steps of refining and combining with other materials becomes first net ore and finally the desired pure metal or league. It is the gross ore (run-of-mine) that has to be recorded as an inflow into the socio-economic system (used materials), while the overburden constitutes the unused portion. All next steps in the refining to arrive at the concentrate and metal are considered to take place within the socio-economic system: the wastes stemming from the gross ore and going into mining waste tips are outputs of the socio-economic system to the natural environment. In the case of timber felling in a non-cultivated forest, wood is felled and branches and leaves are removed and left (unused) in the forest; the used portion consist only in the logs which are usually kept in the open for a certain period of drying, before they are transported out of the woodland. Soil that is excavated in a construction activity may be used in the making of mortar or incorporated in the building otherwise, thus avoiding the extraction from a quarry of a similar quantity of sand and gravel. In this case, the excavated soil is considered as used; however, if it is simply thrown away, the soil remains unused, though moved.

Unused materials are dissimilar from the inputs and the outputs recorded in supply and use tables; these are meant to account for the materials actually going through human activities. However, we will include them in extended supply and use tables, as appended items under the bottom "total use by activity" and "total supply by activity" lines. The quantity of an unused material flow appears twice

in each table, as it is considered, for the accounting purposes, as if they were at the same time a flow in both directions for both systems.

### 2.3. Main categories of flows

Different kinds of materials can be identified in national MFAcc that are relevant in relation to the problems to be tackled by making use of data from the system. A first classification of the materials is connected to the system boundary defined above. Just by considering the flows between the socio-economic system and the natural system and within the socio-economic one, we may distinguish the following types of flows:

- Environmental resources that flow from the environment to the socio-economic system. All environmental resources originate in the environmental system. Most of them remain there and so do not enter the physical flow accounts. By definition, the socio-economic system does not contribute to the output of environmental resources. It is useful to further distinguish environmental resources into:
  - Natural resources such as minerals, energy resources, water used to be embodied in products or stocks of the socio-economic system, soil and biological resources.
  - Ecosystem inputs cover the water and other natural inputs like nutrients and carbon dioxide required by plants and animals for growth, and the oxygen necessary for combustion; this excludes water, nutrients or oxygen supplied as products by the economy.
- Products that are the result of transformation activities, which flow exclusively within the socio-economic system. These are produced within the socio-economic system and used in human activities. Transformation may consist in the simple separation from the rest of nature of a natural resource, which from the moment it is extracted becomes a product (and precisely a raw material). In most products, the natural resources that have contributed to their production are easily identifiable, unlike ecosystem inputs. Nevertheless, at the moment when resources and ecosystem inputs are taken from the natural environment, they enter the socio-economic system and their matter is thereafter embodied in products, whatever the degree of processing of the materials.
- Residuals that are incidental and undesired outputs human activities that have an economic value of zero (or a negative value) to the generator. The term "residuals" is used to cover all solid, liquid and gaseous wastes. Residuals mainly flow inside the socio-economic system and from it to the environment, while only minor quantities are taken back in the socio-economic system from the natural environment once dumped in it. It is important to note that residuals may have a positive value for a unit other than the generator; for example, household waste collected for recycling has no value to the household but may have some value to the recycler. Scrap materials that have a value realisable by the generator (discarded equipment for example) are treated as products and not as residuals.

Figure 3.1 shows the flows visible in the black-box approach. Natural resources (flow NR in the figure) and ecosystem inputs (EI) flow into the socio-economic system from the natural environment, and residuals flow in the inverse direction (WA1), but for the minor flow of residuals taken from the natural environment.

In addition to the materials actually flowing through the socio-economic system, we are also interested in the man-made flows of unused materials. These may also be thought of as environmental resources that remain within the environmental sphere, in whose flows we are interested only to the extent that these materials are relocated by human activity without being used in it, i.e. not becoming products.

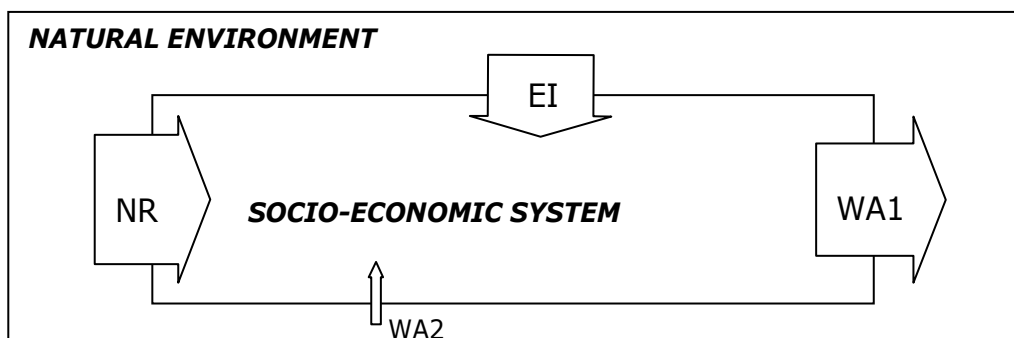
**Figure 3.1: Flows between the natural environment and the socio-economic system**

#### 2.4. Classifications for different kinds of materials

For a classification of natural resources reference can be made to Chapter 5; it should be borne in mind however that the system boundary adopted there is slightly different from the one adopted in the present chapter and this has consequences for the items to be included in such a classification (in particular the harvesting of cultivated biomass is considered an input to the socio-economic system in EW-MFAcc while these are not natural resources according to the present chapter's system boundary). As for the classification of ecosystem inputs, the one proposed in our sample supply and use tables may be sufficient also for implementation, given the low interest of these materials (but for CO<sub>2</sub> inputs to cultivated plants, which is worth considering separately).

A number of international standards exist for the classification of products (for example the Harmonised Commodity Description and Coding System, the Standard International Trade Classification, and the Central Product Classification). The 1993 SNA introduced the Central Product Classification (CPC) for this purpose. It should be noted that the CPC has been developed primarily for economic analysis and that supplementary classifications may be used for the analysis of physical characteristics. For example, the Chemical Abstract System (CAS) together with a toxicity database can be used to identify harmful effects of chemicals. However, in order to ensure international comparability and coherence with the SNA it seems appropriate to ensure that any supplementary classification introduced in the physical flow accounts can be re-aggregated to the CPC.

The concept of residuals embraces so-called dissipative losses from, for example, car brakes and tyres, abrasion from roads, zinc from rain collection systems on roofs, as well as residuals corresponding to deliberate disposals of products such as pesticides, fertilisers and compost, to the extent that they are not absorbed by plants in the current accounting period. The latter as well as thawing materials applied to roadways in winter, are examples of products deliberately transmitted to the environment and that thus need to be included in the flows from the socio-economic system into the environment. Planted seeds, as well as the portion of fertilisers absorbed by plants are in principle internal flows of the socio-economic system (they may however not be sufficiently large in quantitative terms to be worth recording).

Household or industrial waste may not be sent to a managed landfill site but may be dumped (possibly illegally) in open country or by the roadside. Tankers at sea may wash their tanks (also illegally) or lose their cargo through being wrecked. Efforts might then be made to recover these residuals from the environment and bring them back into the socio-economic system either for treatment or consignment to a landfill site. Only in the case of clean-up of residuals previously deposited in the environment there is a re-absorption of residuals by the economy. This is the only case where flows of residuals from the environment to the socio-economic system should be recorded. In numerical terms, the amount may be small but in respect of particular incidents (the wreck of an oil tanker near a

protected coast, say) or in particular locations may arouse a sufficient degree of concern to merit identifying these flows explicitly. This may be the case also for cleaning of contaminated soil and similar cases.

The criterion that a residual is an output from human activities without monetary value to the generator may be difficult to apply in practice, as the necessary information on whether a potential residual has a price or not may not be available in many cases. Further, the strict use of the price criterion means that depending on the market situation, a material can either be defined as a residual or as a product in different periods or even in the same period, which may disturb the interpretation of the flow of residuals. In practice therefore residuals are usually defined and described by means of specific lists of materials. This has a number of practical advantages, e.g. the results of waste statistics can be utilised directly when following the list approach. Currently there is no complete classification for residuals. As for natural resources, a list of the residuals flowing between the socio-economic system to nature exists for the applications described in Chapter 5 (EW-MFAcc); also in this case, the different system boundary might have some consequence for the items to be included in a residuals classification; in addition, residuals that circulate inside the socio-economic system are dealt with in the present chapter but not in EW-MFAcc (except for those going to managed landfill sites).

## 2.5. Example PSUTs

For the purpose of exemplification, we will use very coarse classifications of the materials belonging to each of the kinds specified above. The restricted number of items of each kind is nevertheless sufficient for illustrating all the main features of the accounting scheme. In practice however the reference classifications for the compilation of the accounts will be much more specific, especially for natural resources and products, and the presentation choices may vary largely.

The material flows of our glass-bowl socio-economic system, considered in a black-box perspective, can be described by a very simple accounting scheme, such as that formed by Table 3.2 and Table 3.3. These tables have only two activity columns each, one for the whole of the socio-economic system and one for the whole of the natural environment, plus a column for the total flows by material. In this scheme we recorded only the cross-boundary flows of the two systems, i.e. their mutual exchanges, while no internal flows of either system is accounted for.

Even in such an aggregate picture, the different materials can be kept distinct to any desired extent. In the example tables we distinguished them to the maximum extent allowed by the coarse classification of the materials we used in the development of the example, and will do so in all subsequent versions of the example supply and use tables. As can be easily verified, total supply and total use by material necessarily are equal for each and every material, and this would be the case whatever the number and aggregation of the materials adopted.

It can be noted that in such a simple scheme, where no internal flows of either system are recorded, whatever has been used by any of the two systems has been supplied by the other and vice versa. For instance it can be seen in the use table that the socio-economic system has absorbed 65 million tonnes (Mt) of the natural resource "fossil fuels", which – as the supply table shows – have been provided by the natural environment.

At this level of aggregation of the activities, PIOTs would not add information but only show explicitly that the 695.1 Mt of materials used by the socio-economic system (natural resources, ecosystem inputs, and a tiny quantity of recuperated residuals) has been provided by the natural environment and that the 543 Mt of materials absorbed by the natural environment (residuals) have been supplied by the socio-economic system. The balance between the total inputs and the outputs of each system – i.e. its net accumulation in whatever kind of materials – is recorded towards the bottom of the supply table, before the rows dedicated to the flows of unused materials. These rows report each flow four times, as a combined effect of the double bookkeeping system and of the fact that each flow is dealt with as being at the same time an input and output of the activity to which is due.

Table 3.2 &amp; Table 3.3: Example use and supply tables dealing with the socio-economic-system-as-a-black-box

Use		Supply	
Socio-economic system	Natural environment	Socio-economic system	Natural environment
H	NE	H	NE
TOTAL USE BY MATERIAL		TOTAL SUPPLY BY MATERIAL	
H+NE	NE	H	H+NE
Natural resources			
N1 - Fossil fuels	65.000	-	65.000
N2 - Ferrous metal ores	5.000	-	5.000
N3 - Non-ferrous metal ores	25.000	-	25.000
N4 - Industrial minerals	15.000	-	15.000
N5 - Construction minerals	140.000	-	140.000
N6 - Non-cultivated biomass	5.000	-	5.000
N7 - Water	15.000	-	15.000
<b>N - All natural resources</b>	<b>270.000</b>	<b>-</b>	<b>270.000</b>
E1 - Water absorbed by cultivated plants and animals	25.000	-	25.000
E2 - Oxygen for combustion and respiration	335.000	-	335.000
E3 - CO2 and nutrients for cultivated plants	65.000	-	65.000
<b>E - All ecosystem inputs</b>	<b>425.000</b>	<b>-</b>	<b>425.000</b>
W1 - GHGs, acidifying substances, ozone layer depleters	288.000	288.000	288.000
W2 - Heavy metals to air	0.020	0.020	0.020
W3 - Other toxic substances to air (POPs, PCBs, etc.)	0.030	0.030	0.030
W4 - Other gaseous residuals (vapour, oxygen, etc.)	215.000	215.000	215.000
W5 - Nutrients to water	0.940	0.940	0.940
W6 - Heavy metals to water	0.010	0.010	0.010
W7 - Other water-polluting residuals (oil spills, solid waste etc.)	1.100	1.000	1.100
W8 - Hazardous waste	0.500	0.500	0.500
W9 - Construction and demolition waste	1.500	1.500	1.600
W10 - Other non-hazardous waste	20.000	20.000	20.000
W11 - Manure, sewage, residual water	16.000	16.000	16.000
<b>W - All residuals</b>	<b>543.000</b>	<b>543.000</b>	<b>0.100</b>
<b>TOTAL MATERIAL USE BY ACTIVITY (all materials = N+E+W)</b>	<b>695.100</b>	<b>543.000</b>	<b>695.100</b>
Unused Materials			
U1 - Wild biota	1.000	1.000	1.000
U2 - Mining overburden	55.000	55.000	55.000
U3 - Soil removal	40.000	40.000	40.000
<b>U - All unused</b>	<b>96.000</b>	<b>96.000</b>	<b>96.000</b>
<b>TOTAL MATERIAL SUPPLY BY ACTIVITY (all materials = N+E+W)</b>	<b>543.000</b>	<b>543.000</b>	<b>1,238.100</b>
Balance (material accumulation by activity)			
Materials			
U1 - Wild biota	1.000	1.000	1.000
U2 - Mining overburden	55.000	55.000	55.000
U3 - Soil removal	40.000	40.000	40.000
<b>U - All unused</b>	<b>96.000</b>	<b>96.000</b>	<b>96.000</b>
<b>Balance (material accumulation by activity)</b>	<b>152.100</b>	<b>152.100</b>	<b>- 152.100</b>

## 2.6. The additions to socio-economic stocks as a net flows aggregate

No flows of products are shown in the tables, since the socio-economic system is dealt with as a black box. From this perspective, we can learn something about what happened inside the system in the reference period only indirectly, by reading the data and using the *a-priori* knowledge provided by the law of matter conservation. In particular, we can see that total aggregated quantity of the materials that have been given back to the natural environment (543 Mt of residuals) is lower than the total aggregated quantity of materials taken from it (695.1 Mt of natural resources and ecosystem inputs plus a tiny quantity of residuals): a certain portion of the inputs of the socio-economic system (precisely, 152.1 Mt of materials) has not given back to the natural environment within the same accounting period. This quantity, by the law of matter conservation, must have been accumulated into the socio-economic system, though we are not able to tell what kind of materials have been accumulated, in which form and for which purposes.

As already noted, the result of this differential calculation of the net addition to the stocks of the socio-economic system is reported in the "balance" row of the supply table. It may be noted that this is equal as absolute quantity to the net aggregated material accumulation in the environment, but of opposite sign (the net aggregated accumulation in the closed system given by the union of the socio-economic and the natural systems is of course null). Indeed the material balance principle for this couple of complementary systems may be expressed as:

- total aggregated inputs to the socio-economic system from the environment –
- total aggregated outputs from the socio-economic system to the environment  $\equiv$
- (net) aggregated material accumulation in the socio-economic system

or equivalently as:

- total aggregated inputs to the environment from the socio-economic system –
- total aggregated outputs from the environment to the socio-economic system  $\equiv$
- (net) aggregated material accumulation in the environment.

These identities define the net use of materials of each of the two systems in the aggregate materials perspective. In this perspective the net use flows of the systems coincide with their respective (net) material accumulations. Their net supply has the same absolute quantity but opposite signs.

The net supply and use of the two systems can be calculated at any level of aggregation by material, e.g. by kind of material (i.e. in the perspective of aggregated natural resources, ecosystem inputs and residuals) or by individual material (i.e. in the perspective of homogeneous natural resources, ecosystem inputs and residuals). In the perspective of the materials aggregated by kind, we have the following net uses for the socio-economic system:

Net aggregated natural resources use: 270 Mt  
 Net aggregated ecosystem inputs use: 425 Mt  
 Net aggregated residuals use: - 542.9 Mt (= 0.1 Mt used – 543 Mt supplied)

Which sum up to the 152.1 Mt net use calculated in the aggregate materials perspective.

The corresponding net supplies are of course of opposite signs. It can be noted that the net uses of the socio-economic system, as far as natural resources and ecosystem inputs are concerned, coincide exactly with its gross uses and with its cross-boundary flows, because these materials only flow in one direction. The case is different for residuals, as there have been not only flows from the socio-economic system to the natural environment but also a flow in the inverse direction, though tiny. In a homogeneous materials perspective, the net supplies of the individual residuals by the socio-economic system would coincide with its gross supplies for all residuals but for "other water-polluting

emissions”, due to the recuperation from the environment of 0.1 Mt of pollutants (e.g. oil spilled that is cleaned up), the only residual that flows from nature to the socio-economic system.

Computing the net accumulation in the focus system as a differential and residual quantity (net use) is a trivial and no-data-demanding exercise after all that comes in it and all that comes out of this system has been computed. This kind of application is the least data-requiring one allowing to determine the net accumulation in the focus system. However, it does not allow telling what where and why has been accumulated, nor does it give any hint about the consistency of the data that enter the account; in fact, any estimation error of the supply and use items results in a non-recognisable error of the balance (of equal amount and opposite sign). This is due to the highly level of aggregation by activity of the scheme; indeed, we considered so far only cross-boundary flows, while accumulation in the socio-economic system is an internal phenomenon, whose qualities can be observed only by looking specifically at the flows going into it, which in turn requires specifying the accumulation subsystem as a part of the socio-economic system.

### 3. SUBDIVIDING THE SOCIO-ECONOMIC SYSTEM ACCORDING TO PURELY PHYSICAL CONCEPTS

#### 3.1. Materials’ transformation and accumulation

In order to be able to compute directly the increase in the stocks of the socio-economic system, and to tell what this system accumulates, we have to start looking inside the black box. For this purpose it is convenient to specify two different activities for the socio-economic system, by distinguishing the materials transformation function from the materials accumulation function.

The transformation subsystem is here defined as to include all human activities but the acts of adding or subtracting materials from the stocks, and comprises current production and consumption activities. The accumulation subsystem therefore coincides with the stocks (capital, consumer durables, and managed landfills). According to this distinction we will record separately the flows concerning transformation (i.e. current inputs and outputs to/from production and consumption) and those concerning accumulation (i.e. all inputs and outputs to/from the stocks)<sup>13</sup>.

#### 3.2. Roles of the transformation and accumulation subsystems

Figure 3.2 shows the material exchanges linking these two subsystems and between them and the natural environment. Transformation activities process the materials extracted from nature – natural resources (flow NR in the figure) as well as ecosystem inputs (EI) – and withdrawn from the stocks – products (PR1) as well as residuals (WA3). At the end of the accounting period, all these materials are in the form of products or of residuals. These products, which have not been destroyed in the same accounting period in which they have been created, have flown by definition into the accumulation subsystem (gross additions to the useful stocks: PR2). The residuals from transformation have been emitted to the natural environment (WA1.1, which is a part of the WA1 flow of Figure 3.1) or stocked inside the socio-economic system (waste in managed landfills: WA4).

As far as the accumulation subsystem is concerned, goods are withdrawn from it in order to be further processed (subtractions from inventories: PR1), and residuals are created within it. Some of these residuals are emitted directly to nature (WA1.2, the other part of the WA1 flow – e.g. isolated buildings that are abandoned, abrasion from roads and zinc from rain collection systems on roofs), while the rest result from the intentional dismissal of end-of-life useful stocks (WA3 - e.g. demolished

<sup>13</sup> It is important to notice that accumulation in physical accounts is measured quite differently than in monetary accounts. In physical accounts, an item remains in the accumulated stock until it is disposed of, all at once, at the point of retirement. This contrasts with the money value of an asset which declines over its lifetime.

buildings, end-of-life vehicles), which means that the materials are taken up by transformation to be processed again and in transformation either become products again (e.g. recycled building materials used in construction, that become part of PR2) or to be stocked again as residuals (becoming part of WA4 as waste to controlled landfills) or to be emitted towards the natural environment (e.g. as air emissions from incineration of durables, part of WA1.1). Tiny quantities of ecosystem inputs may go from the natural environment to the stocks (e.g. oxygen bound to rusting structures); let us overlook them.

**Figure 3.2: Flows between the natural environment and the socio-economic system and between the transformation and accumulation subsystems**

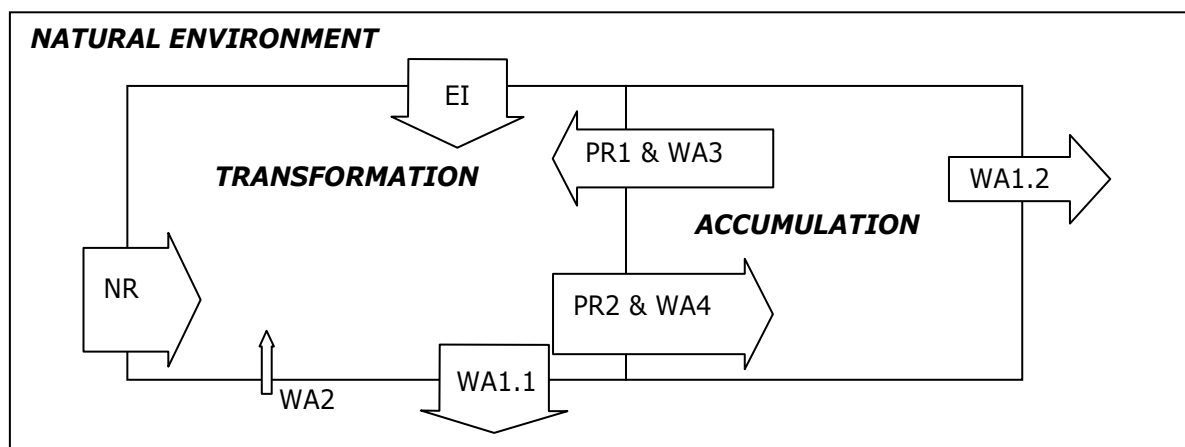

### 3.3. Example PIOTs describing flows by kind of material

Table 3.4 reports in numerical terms, with reference to our glass-bowl-country example, the input-output relationships graphically shown in Figure 3.2. Nine non-null flows are reported, as in the figure. The first four tables show the flows separately for the different categories of materials (all except unused materials); the last one shows the flows aggregated for all materials and is the sum of the other four tables. The tables are perfectly symmetric, i.e. the row and column headings are identical; data are included for all flows between the different "activities". The last table has an additional row where we record the difference between the total inputs and the total outputs of each activity (i.e. its net material accumulation).

The PIOTs in Table 3.4 record the same situation described in Table 3.2 and Table 3.3, but provide additional information in the cells with white background. The information in the cells with a grey background was present already in the black-box supply and use tables, while the black cells in principle could report data (i.e. the flows exist) but the corresponding flows have momentarily been excluded from our observation field. Additional information which was not visible in the black-box description is present in two respects:

- 1) as far as the total cross-boundary flows between the two main systems are concerned, they of course remain unchanged in their total but we can now see how this total is distributed among the two subsystems of the socio-economic system. We can see in particular that:
  - a) all the inputs from nature (270 Mt of natural resources and 425 Mt of ecosystem inputs, as well as the 100 thousand tonnes of residuals) have been taken by the transformation subsystem. In particular the environmental resources, by their very definition, can only flow from the natural environment to the socio-economic system and not within the latter nor from the latter to the former. As a consequence, the first two partial PIOTs, referred to natural resources and ecosystem inputs respectively, present non-zero values only in the "Natural environment" row. It can be noted moreover that for each of the two types of materials this

row will always be equal to the corresponding row of the use table. We will therefore omit these two tables in the development of the numerical example in the next subsections.

- b) transformation activities provide most of the residuals expelled towards the environment but not all of them (536.3 Mt out of the total 543 Mt). Indeed, some residuals also flow from the stocks directly to nature, though in minor quantities (6.7 Mt in the example).
- 2) as far as the internal flows of the socio-economic system are concerned, i.e. the exchanges between its parts, additional flows are now reported that were not visible before. As can be read in the last table, these flows amount on the whole to 421.6 Mt. From the third and fourth table we can see that these are given by two very different kinds of flows:
- a) flows of products, in our example 364.5 Mt. From the third table we can also see that 249 Mt of matter has gone to the stocks in this form, and that the stocks supplied to transformation activities 115.5 Mt of products, due in particular to the fact that they comprise the inventories.
  - b) flows of residuals, in our example 57.1 Mt. From the fourth table we can see that the biggest flow of residuals internal to the socio-economic system is that going from production to the stocks (41.2 Mt), due to the fact that the latter comprise controlled landfills. However a considerable quantity of residuals have also been given by the stocks to transformation (15.9 Mt), as wastes resulting from the dismissing of some useful stocks. These wastes are taken care of by the transformation subsystem, partly to be reused or recycled, i.e. transformed into products again, partly to be finally disposed of.

### 3.4. Example PSUTs

The PIOTs in Table 3.4, due to the level of aggregation by kind of material, do not allow to go into further detail about which natural resources, ecosystem inputs, products and residuals flow between the systems and subsystems. This information would be provided by even more detailed IO tables, dedicated each to an individual environmental resource, product or residual. It is provided also, in a condensed and much less data-requiring form, by the supply and use tables reported in Table 3.5 & Table 3.6, where the cells with a grey background report information already present in Table 3.4. On the basis of these tables we are able to tell how the total inputs and outputs of each system or subsystem are composed in terms of the individual materials. For instance we can see which products and wastes have been stored in the stocks of the socio-economic system and which have been supplied by these stocks: in our example, most of the products absorbed by the stocks are building materials, while energy commodities prevail among the products supplied; non-hazardous wastes prevail among the waste stocked, while construction and demolition waste prevail among the residual flows from stocks to transformation.

### 3.5. Treatment of the internal flows of the socio-economic system and measure of its total flows

Having broken down the socio-economic system into different components, even if only two, allows us to distinguish different ways of measuring its total flows, according to whether its internal flows are accounted for or not. Indeed it should be noted that in Table 3.2 and Table 3.3 the flows recorded under the "total socio-economic system" heading are for some items different (smaller) than the ones recorded under the same heading in Table 3.5 & Table 3.6. This is because in the first couple of tables we recorded only the cross-boundary flows of the socio-economic system, while in the second couple the uses and supplies recorded are gross of the exchanges between the transformation and the accumulation subsystems, as shown in Table 3.4. While the measure of the total cross-boundary flows does not change as internal differentiations of the systems are introduced, but only their composition by activity is revealed, the measure of the total flows is going to be the bigger as more detail by activity is introduced.

**Table 3.4: Example PIOTs describing the relationships between the environment and the material transformation and accumulation subsystems of the socio-economic system**

Input-output table for <u>Natural resources</u>		Socio-economic system			Natural environment	TOTAL MATERIAL SUPPLY BY ACTIVITY
		Material transformation	Material stocks	Total socio-economic system		
		T	S	H=T+S	NE	H+NE
Socio-economic system	Material transformation - T	-	-	-	-	-
	Material stocks - S	-	-	-	-	-
	Total socio-economic system - H	-	-	-	-	-
Natural environment - NE		270.000	-	270.000	-	270.000
TOTAL MATERIAL USE BY ACTIVITY - H+NE		270.000	-	270.000	-	270.000

Input-output table for <u>Ecosystem Inputs</u>		Socio-economic system			Natural environment	TOTAL MATERIAL SUPPLY BY ACTIVITY
		Material transformation	Material stocks	Total socio-economic system		
		T	S	H=T+S	NE	H+NE
Socio-economic system	Material transformation - T	-	-	-	-	-
	Material stocks - S	-	-	-	-	-
	Total socio-economic system - H	-	-	-	-	-
Natural environment - NE		425.000	-	425.000	-	425.000
TOTAL MATERIAL USE BY ACTIVITY - H+NE		425.000	-	425.000	-	425.000

Input-output table for <u>Products</u>		Socio-economic system			Natural environment	TOTAL MATERIAL SUPPLY BY ACTIVITY
		Material transformation	Material stocks	Total socio-economic system		
		T	S	H=T+S	NE	H+NE
Socio-economic system	Material transformation - T	-	249.000	249.000	-	249.000
	Material stocks - S	115.500	-	115.500	-	115.500
	Total socio-economic system - H	115.500	249.000	364.500	-	364.500
Natural environment - NE		-	-	-	-	-
TOTAL MATERIAL USE BY ACTIVITY - H+NE		115.500	249.000	364.500	-	364.500

Input-output table for <u>Residuals</u>		Socio-economic system			Natural environment	TOTAL MATERIAL SUPPLY BY ACTIVITY
		Material transformation	Material stocks	Total socio-economic system		
		T	S	H=T+S	NE	H+NE
Socio-economic system	Material transformation - T	-	41.200	41.200	536.300	577.500
	Material stocks - S	15.900	-	15.900	6.700	22.600
	Total socio-economic system - H	15.900	41.200	57.100	543.000	600.100
Natural environment - NE		0.100	-	0.100	-	0.100
TOTAL MATERIAL USE BY ACTIVITY - H+NE		16.000	41.200	57.200	543.000	600.200

Input-output table for <u>ALL MATERIALS</u>		Socio-economic system			Natural environment	TOTAL MATERIAL SUPPLY BY ACTIVITY
		Material transformation	Material stocks	Total socio-economic system		
		T	S	H=T+S	NE	H+NE
Socio-economic system	Material transformation - T	-	290.200	290.200	536.300	826.500
	Material stocks - S	131.400	-	131.400	6.700	138.100
	Total socio-economic system - H	131.400	290.200	421.600	543.000	964.600
Natural environment - NE		695.100	-	695.100	-	695.100
TOTAL MATERIAL USE BY ACTIVITY - H+NE		826.500	290.200	1,116.700	543.000	1,659.700
Balance (material accumulation by the activity)		-	152.100	152.100	-152.100	

**Table 3.5 & Table 3.6: Physical Use and Supply tables, with the stocks of the socio-economic system distinct from transformation activities**

		Socio-economic system				Natural environment	TOTAL USE BY MATERIAL
		Material transformation	Material stocks	Total socio-economic system			
		T	S	H+T+S	NE	H+NE	
Use	Natural resources	N1 - Fossil fuels N2 - Ferrous metal ores N3 - Non-ferrous metal ores N4 - Industrial minerals N5 - Construction minerals N6 - Non-cultivated biomass N7 - Water	65,000 5,000 25,000 15,000 140,000 5,000 15,000	- - - - - - -	65,000 5,000 25,000 15,000 140,000 5,000 15,000	- - - - - - -	65,000 5,000 25,000 15,000 140,000 5,000 15,000
		<b>N - All natural resources</b>	<b>270,000</b>	<b>-</b>	<b>270,000</b>	<b>-</b>	<b>270,000</b>
		E1 - Water absorbed by cultivated plants and animals	25,000	-	25,000	-	25,000
		E2 - Oxygen for combustion and respiration	335,000	-	335,000	-	335,000
		E3 - CO2 and nutrients for cultivated plants	65,000	-	65,000	-	65,000
		<b>E - All ecosystem inputs</b>	<b>425,000</b>	<b>-</b>	<b>425,000</b>	<b>-</b>	<b>425,000</b>
		P1 - Animal and vegetable products	11,000	7,500	18,500	-	18,500
		P2 - Stone, gravel and building materials	18,000	157,000	175,000	-	175,000
		P3 - Energy commodities	59,000	44,000	103,000	-	103,000
		P4 - Metals, machinery, etc.	10,000	15,000	25,000	-	25,000
	P5 - Plastic and plastic products	4,500	5,500	10,000	-	10,000	
	P6 - Wood, paper, etc.	3,000	8,500	11,500	-	11,500	
	P7 - Water, chemicals and other commodities	10,000	11,500	21,500	-	21,500	
	<b>P - All products</b>	<b>115,500</b>	<b>249,000</b>	<b>364,500</b>	<b>-</b>	<b>364,500</b>	
	W1 - GHGs, acidifying substances, ozone layer depleters	-	-	-	288,000	288,000	
	W2 - Heavy metals to air	-	-	-	0.020	0.020	
	W3 - Other toxic substances to air (POPs, PCBs, etc.)	-	-	-	0.030	0.030	
	W4 - Other gaseous residuals (vapour, oxygen, etc.)	-	-	-	215,000	215,000	
	W5 - Nutrients to water	-	-	-	0.940	0.940	
	W6 - Heavy metals to water	-	-	-	0.010	0.010	
	W7 - Other water-polluting residuals (oil spills, solid waste etc.)	0.200	-	0.200	1,000	1,200	
	W8 - Hazardous waste	1,000	10,700	11,700	0.500	12,200	
	W9 - Construction and demolition waste	11,300	13,000	24,300	1,500	25,800	
	W10 - Other non-hazardous waste	3,500	17,500	21,000	20,000	41,000	
	W11 - Manure, sewage, residual water	-	-	-	16,000	16,000	
	<b>W - All residuals</b>	<b>16,000</b>	<b>41,200</b>	<b>57,200</b>	<b>543,000</b>	<b>600,200</b>	
	<b>TOTAL MATERIAL USE BY ACTIVITY (all materials = N+E+P+W)</b>	<b>826,500</b>	<b>290,200</b>	<b>1,116,700</b>	<b>543,000</b>	<b>1,659,700</b>	
Supply	Natural resources	N1 - Fossil fuels N2 - Ferrous metal ores N3 - Non-ferrous metal ores N4 - Industrial minerals N5 - Construction minerals N6 - Non-cultivated biomass N7 - Water	- - - - - - -	- - - - - - -	- - - - - - -	65,000 5,000 25,000 15,000 140,000 5,000 15,000	65,000 5,000 25,000 15,000 140,000 5,000 15,000
		<b>N - All natural resources</b>	<b>-</b>	<b>-</b>	<b>-</b>	<b>270,000</b>	<b>270,000</b>
		E1 - Water absorbed by cultivated plants and animals	-	-	-	25,000	25,000
		E2 - Oxygen for combustion and respiration	-	-	-	335,000	335,000
		E3 - CO2 and nutrients for cultivated plants	-	-	-	65,000	65,000
	<b>E - All ecosystem inputs</b>	<b>-</b>	<b>-</b>	<b>-</b>	<b>425,000</b>	<b>425,000</b>	
	P1 - Animal and vegetable products	7,500	11,000	18,500	-	18,500	
	P2 - Stone, gravel and building materials	157,000	18,000	175,000	-	175,000	
	P3 - Energy commodities	44,000	59,000	103,000	-	103,000	
	P4 - Metals, machinery, etc.	15,000	10,000	25,000	-	25,000	
	P5 - Plastic and plastic products	5,500	4,500	10,000	-	10,000	
	P6 - Wood, paper, etc.	8,500	3,000	11,500	-	11,500	
	P7 - Water, chemicals and other commodities	11,500	10,000	21,500	-	21,500	
	<b>P - All products</b>	<b>249,000</b>	<b>115,500</b>	<b>364,500</b>	<b>-</b>	<b>364,500</b>	
	W1 - GHGs, acidifying substances, ozone layer depleters	287,000	1,000	288,000	-	300,000	
	W2 - Heavy metals to air	0.020	-	0.020	-	0.020	
	W3 - Other toxic substances to air (POPs, PCBs, etc.)	0.030	-	0.030	-	0.030	
	W4 - Other gaseous residuals (vapour, oxygen, etc.)	211,000	4,000	215,000	-	215,000	
	W5 - Nutrients to water	0.940	-	0.940	-	0.940	
	W6 - Heavy metals to water	0.010	-	0.010	-	0.010	
	W7 - Other water-polluting residuals (oil spills, solid waste etc.)	1,000	0.100	1.100	0.100	1.200	
	W8 - Hazardous waste	11,200	1,000	12,200	-	12,200	
	W9 - Construction and demolition waste	13,000	12,800	25,800	-	25,800	
	W10 - Other non-hazardous waste	37,300	3,700	41,000	-	41,000	
	W11 - Manure, sewage, residual water	16,000	-	16,000	-	16,000	
	<b>W - All residuals</b>	<b>577,500</b>	<b>22,600</b>	<b>600,100</b>	<b>0.100</b>	<b>600,200</b>	
	<b>TOTAL MATERIAL SUPPLY BY ACTIVITY (all materials = N+E+P+W)</b>	<b>826,500</b>	<b>138,100</b>	<b>964,600</b>	<b>695.100</b>	<b>1,659.700</b>	
	Balance (material accumulation by activity)	-	152,100	152,100	-152,100	-	
Unused Materials	U1 - Wild biota	1,000	-	1,000	1,000	1,000	
	U2 - Mining overburden	55,000	-	55,000	55,000	55,000	
	U3 - Soil removal	40,000	-	40,000	40,000	40,000	
	<b>U - All unused</b>	<b>96,000</b>	<b>-</b>	<b>96,000</b>	<b>96,000</b>	<b>96,000</b>	

It can be noted that at this aggregation level we did not show the internal flows of any of the individual entities (the two subsystems of the socio-economic system and the natural system): this can be seen from Table 3.4, where we did not include figures in the cells of the main diagonal of the tables even if the corresponding flows exist (black cells). Including or not in the account these flows makes a big difference for the data reported in the SUTs for the respective entities, since they would have to be included both among their supplies and among their uses. In this case it would not be possible to know from the SUTs how much of the inputs and of the outputs of that entity are in reality exchanges with other entities and how much are internal flows of that entity.

We have for the moment excluded the internal flows of the individual entities from the account because this would make it difficult, if not impossible, to read in the SUTs the information concerning the quantities of materials that each entity provides to or draws from the other entities. The information content of the SUTs is thus maximised and the need for PIOTs reduced. The only apparent disadvantage is that the total internal flows of the socio-economic system as a whole seems to depend on the number of subsystems in which it is divided: the larger their number, the more internal flows captured, the bigger the total (see Chapter 1.6). It should be clear however that the flows do not change in reality, and this is only a consequence of looking closer and closer at the system.

We will exclude the internal flows of the most disaggregated entities also in the next versions of our sample SUTs and PIOTs schemes. For coherence with monetary input-output tables, an exception will be done for the internal flows of the individual production activities, dealt with in section 5 of the present chapter. For the purpose of NMFacc, also the measurement of the internal flows of these activities must be coherent with current national accounting practices to ensure comparability between monetary and physical aggregates; in particular, the elementary units whose flows are measured must be the same (e.g. local kind of activity).

### 3.6. Mixed recording of gross and net flows and summary example PIOT

The distinction between gross and net flows is a general one that applies to all entities and the calculation rule is the same given for the socio-economic system as a whole in the previous section. By applying this procedure, we can calculate the net additions to the stocks, as these are nothing else than their net flows and know how these are composed by material kind. We can now see flows of products going into the accumulation subsystem, and products and residuals going out of it, and thus tell that the 152.1 Mt of accumulated materials are the result of a net use of products of  $249 - 115.5 = 133.5$  Mt and of residuals of  $41.2 - 15.9 - 6.7 = 18.6$  Mt.

Besides calculating the net flows of an entity, we might want to record only these net flows in the tables, changing the definition of the entity (this is useful especially in the cases where only data on net flows are available). In the case of the stocks, we should in this case change the name of the accumulation subsystem from "stocks" to "net additions to stocks". "Net additions to stocks" would have non-zero values only in the use table; these values would be equal for each material to the difference between the quantity of that material used by the stocks (as reported in Table 3.5) and the quantity of the same material supplied by them (as reported in Table 3.6). The column for the "net additions to stocks" in the supply table would be null and could therefore be dropped without loss of information.

If we choose to record "net additions to stocks" only, we are concentrating on their role of "sink" of materials, i.e. as destination of the materials that are not given back to the environment by human activities. If on the contrary we want to emphasise the role of net supplier or of source of materials of some entity, we have to net out the (supposedly minor) quantities of materials which that activity uses from those it supplies, and record only its net (out)flows in the supply table. In both cases, if we drop the null columns, we have SUTs pairs where not exactly all the same entities are reported in both tables.

Moreover, we might want to emphasise different roles of the same entity with respect to different kinds of materials. In this case, we may record for a given entity only the net (in)flows of a certain material category in the use table (emphasis on the role of user or sink of the entity for those materials) and only the net (out)flows in the supply table (emphasis on the role of supplier or source of that entity for those materials). For example in the case of stocks we may record the net uses for products and the net supplies for residuals. This would amount to splitting the overall net addition to stocks into a net inflow of products and a net outflow of residuals.

Also the PIOTs of Table 3.4 report gross flows from/to stocks. We might want, however, to report also in a PIOT some flows net instead of gross, e.g. for coherence with the monetary IOTs. In order to report for a given "sink" entity net uses only, we have to replace the column of this activity by the difference between it and the corresponding row transposed, where the quantities supplied by the same entity are recorded. The row could then be omitted. This operation results in a not perfectly symmetric table, since the entities specified in the rows are not the same as those in the columns anymore.

Alternatively we may want to replace some row with the difference between it and the transposed column of the same entity, and drop the column. Whether it is the row or the column that we want to drop from the IOT depends on whether we want to highlight the function of net user or "sink" (column) or that of supplier or source (row) of the entity. We might even want to highlight the different roles played by the same entity with respect to different materials, i.e. to record net supply flows for some materials and net use flows for other materials, e.g. the environment is a pure supplier of natural resources and a net absorber of residuals.

In our three entities case, for instance, starting from the last block of Table 3.4, we can condensate most of the information contained in the first four tables of the same figure, by:

- reporting the net uses of products by accumulation in a specialised column of the IO table (without the corresponding row which would be null) and separating this column from that dedicated to accumulation of residuals in controlled landfills and other waste storage (which we continue to record gross, in both row and column),
- splitting the natural environment row into the supply of natural resources, ecosystem inputs and residuals, so that they can be reported separately.

The table now is that of Table 3.7, which reports information that was already present or could be deducted from Table 3.4. In this condensed table we can immediately see, for instance, that the net flow of products from transformation to net additions to stocks is equal to 133.5 Mt. This corresponds to the difference between the gross flow of products from transformation to stocks (249 Mt) and the gross flow of products from stocks to transformation (115.5 Mt).

Table 3.7 hints to how it is possible to expand the natural environment row and column of a summary PIOT in order to keep the desired detail on the composition by material of inputs and/or outputs involving the natural system. In principle there is no limit to this disaggregation, which is implemented to a high degree of detail in partial realisations of the accounting scheme presented in this chapter (Chapter 4)

It is always advisable to compile the accounts by recording gross flows whenever possible, and to aggregate the information for presentation purposes and according to monetary national accounting standards only in a second stage.

**Table 3.7: Example aggregate summary PIOT with net products' use by accumulation and details by kind of material**

		Socio-economic system				Natural environment - absorption of residuals <i>NE</i>	TOTAL MATERIAL SUPPLY BY ACTIVITY <i>H+NE</i>
		Material transformation <i>T</i>	Accumulation of products <i>S1</i>	Accumulation of residuals <i>S2</i>	Total socio-economic system <i>H=T+S1+S2</i>		
Socio-economic system	Material transformation - <i>T</i>	-	133.500	41.200	174.700	536.300	711.000
	Material stocks - Residuals only	15.900	-	-	15.900	6.700	22.600
	<b>Total socio-economic system - <i>H</i></b>	<b>15.900</b>	<b>133.500</b>	<b>41.200</b>	<b>190.600</b>	<b>543.000</b>	<b>733.600</b>
Natural environment	Natural resources - <i>N</i>	270.000	-	-	270.000	-	270.000
	Ecosystem Inputs - <i>E</i>	425.000	-	-	425.000	-	425.000
	Residuals - <i>W</i>	0.100	-	-	0.100	-	0.100
	<b>Natural environment - <i>NE</i></b> (All materials - <i>N+E+W</i> )	<b>695.100</b>	-	-	<b>695.100</b>	-	<b>695.100</b>
<b>TOTAL MATERIAL USE BY ACTIVITY - <i>H+NE</i></b>		<b>711.000</b>	<b>133.500</b>	<b>41.200</b>	<b>885.700</b>	<b>543.000</b>	<b>1,428.700</b>
Balance (material accumulation by the activity)		-	152.100		152.100	-152.100	

#### 4. SUBDIVIDING THE SOCIO-ECONOMIC SYSTEM ACCORDING TO ECONOMIC CONCEPTS

The socio-economic system is a complex system in which a large number of different activities are carried out. In the present section we refine the analysis of its material metabolism by introducing a more detailed and analytically meaningful partition of its activities, building on the one already introduced into transformation and accumulation. We will establish this further partition on the basis of the conjunction of these purely physical concepts with economic categories, in consideration of the importance of economic forces in determining the flowing of materials between the environment and the socio-economic system and within the latter. Such a partition makes the comparison between physical and monetary aggregates meaningful; moreover it makes a more detailed analysis of both of the cross-boundary and internal material flows of our focus system possible. For the sake of exposition, in the present section we will continue pretending that the whole world is a single country, or that our focus country is under a glass bowl.

##### 4.1. Value flows and material flows: two distinct aspects of human activities

In order to make proper use of national accounting concepts in material flows accounting, it is convenient to recall here what is covered in the accounts of the SNA – and what is not – by quoting the SNA itself:

“The accounts of the System are designed to provide analytically useful information [...] by recording the values of the goods, services or assets involved in the transactions between institutional units that are associated with these activities rather than by trying to record or measure the physical processes directly. For example, the accounts do not record the physical consumption of goods and services by households - the eating of food or the burning of fuel within a given time period. Instead, they record the expenditures that households make on final consumption goods and services or, more generally, the values of

the goods and services they acquire through transactions with other units, whether purchased or not" (par. 1.12 SNA93).

A physical accounting scheme of socio-economic metabolism such as the one we are setting up covers an aspect of human activities different from that covered in the SNA, since it records and measures the physical processes directly. Indeed, it constitutes a satellite system of national accounts of the type that "is mainly based on concepts that are alternatives to the ones of the SNA" (SNA, ch. XXI, §21.46). However, a parallel can be established between some physical flows recorded in NMFacc and some value flows recorded in national accounts. It is by using this parallel that we get interesting information linking the two plans, e.g. about material intensities per unit values.

#### **4.2. Relation of the economic categories of production, consumption and capital formation to material transformation and accumulation**

An appropriate subdivision of the activities of the socio-economic system is necessary for establishing a correct parallel between physical and value flows. Three types of economic activity are covered in the SNA: production, consumption and accumulation. It is necessary to clarify how these economic concepts – which point to the role of the activities in the creation/circulation of economic value – relate to the purely physical concepts of transformation and accumulation.

"Production" cannot be referred as such to materials, since in the physical domain (differently from that of value) there is no creation, but only transformation or accumulation of matter. It is clear that every economic production process, involving a change in the physical state of some matter, is a material transformation process. However, not all man-made transformations of matter are productive in national accounting terms. "Production" therefore identifies certain activities on the basis of their role on the value plan; it can be used on the material plan by extension, in order to distinguish these activities from other transformation activities and describe their physical aspect in PSUTs and PIOTs.

Also "consumption" cannot be referred as such to materials, since in the physical domain there is no destruction; as for "production" however it can be used to identify certain activities on the basis of their role on the value plan. Let us first of all distinguish intermediate from final consumption. Intermediate consumption refers to the use of products as inputs in production activities, whose result from the physical point of view is the transformation of these products partly into residuals and partly into other products. Final consumption refers to the acquisition of goods and services by households for non-productive uses, including human metabolism. The products used in final consumption may be transformed in residuals in the same accounting period or in later accounting periods. Let us therefore further distinguish household's final consumption into two kinds of activities:

- ♦ Current final material consumption activities, that transform products into residuals within the same accounting year in which they are purchased; from the physical point of view these activities are not different from production activities: the only difference is that there are no products between their outputs (otherwise they would be production activities). This reflects their role in the value creation/circulation chain. Current final consumption belongs to the transformation subsystem, along with production activities.
- ♦ The purchase, disposal and dissipation of consumer durables, i.e. of goods that are not transformed into residuals in the same accounting period in which they are purchased by households for final consumption purposes; these activities belong to the accumulation subsystem. Durable goods are indeed part of the stocks of the socio-economic system and are not different, from the physical point of view, from other products intended for repeated use (capital). However, they are not assets in an economic sense, as they are not able to produce economic benefits for the ones who hold them. Therefore, we will keep them distinct from other stocks and the exchanges involving them distinct from other final consumption activities.

"Accumulation" as such can be referred to materials but it is important to note that:

- ◆ not all storage of economic value has an immediate counterpart in the physical stocking of materials inside the socio-economic system (i.e. economic assets may be immaterial: e.g. financial assets, software);
- ◆ not all physical stocks of materials inside the socio-economic system represent a storage of economic value.

The second circumstance is the most important for the partition of activities to be used in physical accounting. Indeed some materials accumulated inside the socio-economic system do not constitute economic assets in themselves. As already seen, one such item are consumer durables; another one is waste stocked in controlled landfills, which does not have any immediate counterpart in the value plan. Both do not constitute accumulation of economic assets as they are not capable of bringing economic benefits to their owners. A perfect correspondence between economic and physical accumulation may be found only for produced tangible assets and for valuables (we will no longer consider the latter for simplicity, as it usually does not represent a big quantity in physical terms, especially if compared to capital goods). For simplicity we will use the name "capital" for these items, which are the "economic" subset of the material accumulation subsystem. We will therefore keep "durables", "capital" and "waste" as distinct parts of the accumulation subsystem, in consideration of their different economic characteristics.

#### 4.3. The importance of production activities in socio-economic material metabolism

Figure 3.3 schematically shows the relationships between the natural environment, production, current final consumption, capital and other material accumulation.

**Figure 3.3: Flows between the environment, production, current final consumption, capital and other material accumulation**

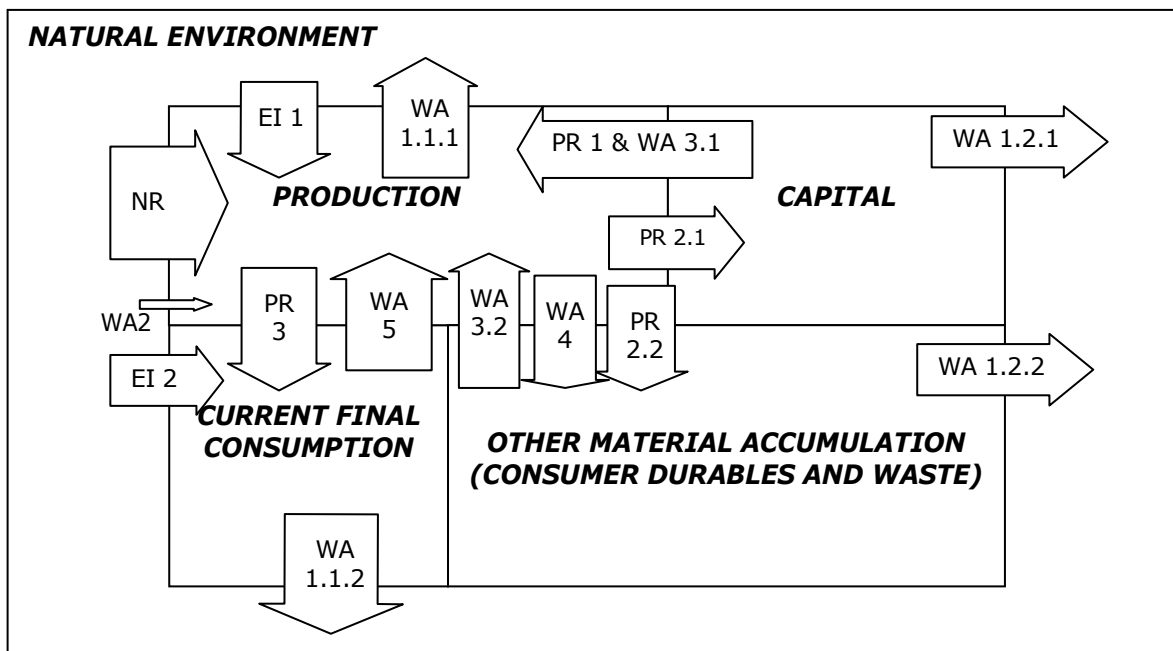

As it can be seen from the figure, production is the most relevant part of the socio-economic system for what concerns its material metabolism. Indeed, production activities are at the centre of all the internal exchanges of the socio-economic system as they:

- take directly from the natural environment all of the natural resources and most of the ecosystem inputs used in the socio-economic system as a whole;

- transform environmental resources into products (all products, by definition, originate within the production subsystem and flow within it and from it to the rest of the socio-economic system, e.g. to non-productive activities of households);
- produce, manage and return to the natural environment most of the residuals generated by the socio-economic system as a whole.

As far as the input side of the socio-economic system is concerned, no natural resources are taken from the natural environment directly by human activities other than production ones. In other words, for these resources the boundary with nature of the socio-economic system as a whole coincides on the input side with the boundary of production with nature, so that for natural resources reference can be made indifferently to the inputs of production as to those of the socio-economic system (flow NR in the figure). For ecosystem inputs the situation is different, since current final consumption directly takes what it needs, e.g., for the combustion processes that take place inside it. We therefore split the EI flow into a EI 1 part – that of production activities – and a EI 2 part – that of current consumption.

As far as the output side of the socio-economic system is concerned, the quantities of residuals given back to the natural environment directly by transformation activities of the socio-economic system (WA 1.1) have also been split in two parts (WA 1.1.1 and WA 1.1.2) according to the part of transformation that directly generates them. A similar subdivision of the residuals given directly to the environment by the accumulation subsystem (WA 1.2) has been done according to its split into capital formation and other material accumulation (respectively WA 1.2.1 and WA 1.2.2).

As far as the internal flows of the socio-economic system are concerned, it is now visible that all materials going from transformation to accumulation are provided by production. Production provides all the other parts of the socio-economic system with all the materials they use, with the only exception of ecosystem inputs (flow EI2); production also receives residuals (waste) from the other parts of the socio-economic system (flows WA3 – now split into WA3.1 from capital formation and WA3.2 from other material stocks – and WA5, a flow that was not visible before, from current final consumption). The residuals given to production are in part transformed into products again, in part given back to the natural environment (e.g. by incineration plants), in part stocked in landfills along with the other residuals generated by production itself (flow WA4).

Current final consumption activities transform the products they receive from production into residuals that are either given back to production (waste for management) or discarded directly in the environment (e.g. gaseous emissions), possibly after having been combined with ecosystem inputs from nature.

#### **4.4. Detail by subsystem in the example tables**

##### **4.4.1 The transformation subsystem**

Production activities are for the moment dealt with collectively and the production subsystem is called industries. These will be later distinguished by kind. Since they are pure transformation activities, their uses are equal, as an aggregate, to their supplies, i.e. their accumulation is exactly zero.

Government consumption is not shown in the examples of the physical flow accounts since it is assumed that government production is included under the industries heading. However, in the national accounts of some countries the details of government inputs may be recorded as final consumption.

##### **4.4.2 The accumulation subsystem**

With respect to Figure 3.3, in the SU and IO example tables of this section we further subdivided the stocks of the socio-economic system, and therefore the flows to and from accumulation, according to

the different kinds of stocks identified so far, which have quite different characteristics. In particular we split *capital formation* into inventories and other capital and *other material accumulation* into consumer durables and controlled landfills and other waste storage. The complete headings of the example tables are therefore as follows:

Socio-economic system											Natural environment	TOTAL MATERIAL SUPPLY BY ACTIVITY
Industries	Households' final consumption			Total material transformation	Capital formation			Controlled landfills & other waste storage	Total material stocks	Total socio-economic system		
	Current final material consumption	Consumer durables	Total households' final consumption		Inventories change	Other capital	Total capital formation					
I	C1	C2	C=C1+C2	T=I+C1	K1	K2	K=K1+K2	L	S=C2+K+L	H=I+C+K+L=T+S	NE	H+NE

Inventories have already been mentioned several times, and their role in the economic cycles should by now be clear; they also include work-in-progress goods, and among these cultivated biological assets yielding products once only on extraction, such as live animals for slaughter and trees cultivated for making timber. Other capital comprises buildings of all sorts, infrastructures, machinery and mature biological assets that yield repeated products.

In distinguishing inventories from other capital we also will record their changes only, rather than their gross flows. Recording additions to the inventories as net flows corresponds to the normal practice in monetary Input-Output tables. This might also be easier in terms of data requirement, since only data on net change may be available. As a consequence the headings are entitled to inventories change. The column of the supply table and the row of the PIOT are empty for this activity and if we wanted to we could omit them from the tables. This corresponds to SNA conventions and facilitates comparison between monetary and physical data.

The controlled storage of waste on landfills or public infrastructure is shown as retention of residuals within the socio-economic system and thus an accumulation within the socio-economic sphere; however, it is not part of capital formation.

The way activities are ordered in the SU and IO tables depends on whether one wants to group the flows prominently according to an economic criterion or to a material transformation/accumulation one. We privileged the first one for the reasons pointed out above. However, we also highlighted the subdivision reflecting the purely material point of view by shading the accumulation headings and keeping subtotal headings for both subsystems, next to the subtotals for the economically relevant subdivisions.

#### 4.5. Flows by kind of material and example PIOTs for products and residuals

The way the different activities are involved in material flows is described here again with a focus on the different materials kinds. For the aggregates of "all products" and "all residuals" this is done by presenting example input output tables. These however do not show the details by individual materials. More information at this level can be found in the supply and use tables, presented below.

##### 4.5.1 Flows of natural resources

Natural resources are drawn from the environment by production activities only. They can be harvested directly by households for own account use, for example fuel wood collected by households, which is a product according to the SNA. In practice measurement of these flows may be difficult.

##### 4.5.2 Flows of ecosystem inputs

Ecosystem inputs flow from the environment to production and to consumption. Industries and households absorb oxygen for combustion and respiration. As for production, they are the most important input to production of biomass products (e.g. agricultural crops and timber in managed

forests), and play a fundamental role in the energetic use of fossil fuels (combustion). Combustion processes take place in household mainly in activities such as own account transport and heating.

### 4.5.3 Flows of products

Products are reported in PSUTs and PIOTs insofar as they incorporate natural resources and ecosystem inputs. By definition all products originate within production, as can be seen in the example of Table 3.8 (where the cells with grey background report information that was already present in Table 3.7 and the black cell could in principle report data). They go:

- to households to satisfy final consumer needs (final consumption):
  - to be transformed in residuals in the same accounting period (current final consumption);
  - to be transformed in residuals after repeated use (durable goods).
- to capital formation:
  - to be used once in production as intermediate inputs in some subsequent accounting period (inventories);
  - to be used as an instrument in production of other products repeatedly and over a period of time longer than the accounting period (other capital).

Products are also used by the industries themselves for the production of other products in the same period in which they are produced (intermediate consumption) but we do not represent this flow in Table 3.8 for the reasons presented in the previous section. There are no internal flows of products between the different components of the stocks, because the activity to move materials from one stock to another would have these materials as input (e.g. construction materials present in the inventories put into a building).

It can be noticed that the figures concerning the exchanges between transformation as a whole (as a black box) and stocks as a whole can be found unchanged in the present version (there only is one non-null flow, 133.5 Mt of net uses of products). Indeed, nothing has changed in our country under the glass bowl, only some more detail has been introduced in the description of its flows. The measure of total products' flows changed with respect to that reported in the products part of Table 3.4 (364.5 Mt) because:

- some additional internal flows of the socio-economic system that could not be "captured" before are now visible, namely internal flows of the transformation subsystem (28.5 Mt from the industry part of transformation to the consumption part);
- some internal flows that were shown before are not reported anymore, namely the flows from and to inventories that have been netted out (115.5 Mt, counted once as input and once as output of the inventories).

The 162 Mt figure is indeed equal to  $(364.5 - 115.5 \times 2 + 28.5)$  Mt, which is also equal to the 133.5 Mt net use of products by the stocks + 28.5 Mt internal flows of transformation now visible.

**Table 3.8: Example PIOT for products with the activities of the socio-economic system subdivided according to economic and material categories and with inventories as net uses**

		Socio-economic system										Natural environment	TOTAL MATERIAL SUPPLY BY ACTIVITY		
		Industries	Households' final consumption			Total material transformation	Capital formation			Controlled landfills & other waste storage	Total material stocks			Total socio-economic system	
			Current final material consumption	Consumer durables	Total households' final consumption		Inventories change	Other capital	Total capital formation						
I	C1	C2	C=C1+C2	T=I+C1	K1	K2	K=K1+K2	L	S=C2+K+L	H=I+C+K+L=T+S	NE	H+NE			
Socio-economic system	Industries - I	-	28.500	10.000	38.500	28.500	- 34.000	157.500	123.500	-	133.500	162.000	-	162.000	
	Households' final consumption	Current final material consumption - C1	-	-	-	-	-	-	-	-	-	-	-	-	-
		Consumer durables - C2	-	-	-	-	-	-	-	-	-	-	-	-	-
		Total households' final consumption - C=C1+C2	-	-	-	-	-	-	-	-	-	-	-	-	-
	Total material transformation - T=I+C1	-	28.500	10.000	38.500	28.500	- 34.000	157.500	123.500	-	133.500	162.000	-	162.000	
	Capital formation	Inventories change - K1	-	-	-	-	-	-	-	-	-	-	-	-	-
		Other capital - K2	-	-	-	-	-	-	-	-	-	-	-	-	-
		Total capital formation - K=K1+K2	-	-	-	-	-	-	-	-	-	-	-	-	-
	Controlled landfills & other waste storage - L	-	-	-	-	-	-	-	-	-	-	-	-	-	-
	Total material stocks - S=C2+K+L	-	-	-	-	-	-	-	-	-	-	-	-	-	-
Total socio-economic system - H=I+C+K+L=T+S	-	28.500	10.000	38.500	28.500	- 34.000	157.500	123.500	-	133.500	162.000	-	162.000		
Natural environment - NE	-	-	-	-	-	-	-	-	-	-	-	-	-	-	
TOTAL MATERIAL USE BY ACTIVITY - H+NE	-	28.500	10.000	38.500	28.500	- 34.000	157.500	123.500	-	133.500	162.000	-	162.000		

#### 4.5.4 Flows of residuals

Products generate residuals in the course of production but also when they are finally consumed and discarded. In physical accounting there are two distinct flows connected to final consumption, unlike in monetary accounting where only the acquisition of the products by households matters. Indeed, also the time of discard is important in physical terms. In monetary accounts only one kind of transaction is recorded concerning final consumption as this is dealt with exclusively under the aspect of the acquisition of products by households. This kind of transaction has an immediate physical aspect, which is recorded in physical accounts. In addition to this, in physical accounts consumption is dealt with also as physical use of the goods resulting in their discard, so there is another flow (of residuals) that does have no correspondence in monetary accounts.

**Table 3.9: Example PIOT for residuals with activities of the socio-economic system subdivided according to economic and material categories**

		Socio-economic system										Natural environment	TOTAL MATERIAL SUPPLY BY ACTIVITY	
		Industries	Households' final consumption			Total material transformation	Capital formation			Controlled landfills & other waste storage	Total material stocks			Total socio-economic system
			Current final material consumption	Consumer durables	Total households' final consumption		Inventories change	Other capital	Total capital formation					
I	C1	C2	C=C1+C2	T=I+C1	K1	K2	K=K1+K2	L	S=C2+K+L	H=I+C+K+L=T+S	NE	H+NE		
Socio-economic system	Industries - I	-	-	-	-	-	-	-	41.200	41.200	41.200	458.500	499.700	
	Households' final consumption	Current final material consumption - C1	7.700	-	-	7.700	-	-	-	-	7.700	77.800	85.500	
		Consumer durables - C2	2.400	-	-	2.400	-	-	-	-	2.400	1.000	3.400	
		Total households' final consumption - C=C1+C2	10.100	-	-	10.100	-	-	-	-	10.100	78.800	88.900	
	Total material transformation - T=I+C1	7.700	-	-	7.700	-	-	-	41.200	41.200	48.900	536.300	585.200	
	Capital formation	Inventories change - K1	-	-	-	-	-	-	-	-	-	-	-	
		Other capital - K2	13.400	-	-	13.400	-	-	-	-	13.400	1.700	15.100	
		Total capital formation - K=K1+K2	13.400	-	-	13.400	-	-	-	-	13.400	1.700	15.100	
	Controlled landfills & other waste storage - L	0.100	-	-	0.100	-	-	-	-	-	0.100	4.000	4.100	
	Total material stocks - S=C2+K+L	15.900	-	-	15.900	-	-	-	-	-	15.900	6.700	22.600	
Total socio-economic system - H=I+C+K+L=T+S	23.600	-	-	23.600	-	-	-	41.200	41.200	64.800	543.000	607.800		
Natural environment - NE	0.100	-	-	0.100	-	-	-	-	-	0.100	-	0.100		
TOTAL MATERIAL USE BY ACTIVITY - H+NE	23.700	-	-	23.700	-	-	-	41.200	41.200	64.900	543.000	607.900		

As also shown in the numerical example of Table 3.9, the residuals generated in final consumption, whether of durables or of non-durables, may be either discarded directly to the natural environment or given back to production activities for management and possibly for reuse and recycling, according to

the kind of residual (e.g. gaseous residuals mostly go directly to the environment, while solid waste mostly is taken care of by specialised activities) and to the organisation of society. In the table it can be seen for instance that current final consumption generates 85.5 Mt of residuals, of which 7.7 Mt are given to production and 77.8 Mt directly discharged into the environment.

Direct residual outputs to the environment come from both production and consumption, as well as from stocks. The direct output of residuals towards the environment in the capital account consists of emissions such as leakage from infrastructure. Part of the residuals are 'used' by the socio-economic system in landfill sites. Leakage and emissions from controlled landfills complete the flows from the socio-economic system to the environment.

We can now see that the small flows of residuals that may occur from the environment to the socio-economic system are an input to activities belonging to the production subsystem. The cleaning-up of polluted sites is indeed a productive activity like many other environmental protection activities.

The gross output of residuals of the socio-economic system is equal to the output of residuals generated in this system, including the amount of residuals that may be re-absorbed in a second stage due to recycling or waste and wastewater treatment. We did not net out residual flows for any activity in our example PIOT, so we can read the measure for the gross residual output visible at the disaggregation level of the present section in the rightmost cell of the "total socio-economic system" table: 607.8 Mt. The net output to the environment can also be read in the table, in the cell next to it: 543 Mt, as we already had seen in Table 3.7 (remember it is a measure independent from aggregation).

#### **4.5.5 Flows of unused materials**

Flows of unused materials are generated exclusively in production activities, since it is only these activities that extract natural resources. It must be recalled that in national accounting production carried out by households for their own consumption is included under the industries. In the supply and use tables presented below, the flows of unused materials hypothesised in our example have therefore been attributed 100% to the industries.

#### **4.6. Summary example PIOT showing details by kind of materials**

Table 3.10 is the result of the application of the further subdivision of the socio-economic system extension to Table 3.7. This table allows to get in a condensed form all of the information present in the detailed tables for products and residuals, as well as on the flows of natural resources and ecosystem inputs. It can be noted that the "Industries" are the only entity that delivers products. Cells with a grey background report information also available in Table 3.7.

#### **4.7. Some accounting treatment remarks**

In general, as far as the accounting of products' mass is concerned, this can be either exclusive or inclusive of packaging. In the coarse classification of products we adopted for our example we did not include a separate item for packaging, therefore in this case it is inclusive. However, while information on weight including packaging can be useful in relation to analysis of transport needs, separate accounting for the goods and the related packaging is normally to be preferred.

For the correct attribution of the flows to the supplying and using activities it is important to note at which stage the flows are generated and the roles of the actors involved. For example:

- food scraps coming from a restaurant will be treated as residuals coming from production;
- the food consumed by a consumer in a restaurant represents a physical flow from a service industry to households final consumption, like the purchase of food from carryout or home

catering, and these flows should be recorded under the flows of products (even though in economic terms the activity is classified as a service activity);

- food scraps coming from the remains of the products delivered by a carry-out service or from home catering will be treated as residuals coming from consumption.

**Table 3.10: Example aggregate summary PIOT with activities of the socio-economic system subdivided according to economic and material categories, net products' uses by accumulation and details by kind of material**

		Socio-economic system											Natural environment	TOTAL MATERIAL SUPPLY BY ACTIVITY	
		Industries (Environmental resources and Residuals)	Households' final consumption			Total material transformation	Capital formation			Controlled landfills & other waste storage	Total material stocks	Total socio-economic system			
			Current final material consumption	Consumer durables	Total households' final consumption		Inventories change	Other capital	Total capital formation						
		I	C1	C2	C=C1+C2	T=I+C1	K1	K2	K=K1+K2	L	S=C2+K+L	H=I+C+K+L=T+S	NE	H+NE	
Socio-economic system	Industries - I	Products	28.500	10.000	38.500	28.500	- 34.000	157.500	123.500	-	133.500	162.000	-	162.000	
		Residuals	-	-	-	-	-	-	-	41.200	41.200	41.200	458.500	499.700	
		All materials	28.500	10.000	38.500	28.500	- 34.000	157.500	123.500	41.200	174.700	203.200	458.500	661.700	
	Households' final consumption	Current final material consumption - C1 (Residuals)	7.700	-	-	-	7.700	-	-	-	-	7.700	77.800	85.500	
		Consumer durables - C2 (Residuals)	2.400	-	-	-	2.400	-	-	-	-	2.400	1.000	3.400	
		Total residuals from households' final consumption - C=C1+C2	10.100	-	-	-	10.100	-	-	-	-	10.100	78.800	88.900	
	Total material transformation - T=I+C1 All materials		7.700	28.500	10.000	38.500	36.200	- 34.000	157.500	123.500	41.200	174.700	210.900	536.300	747.200
	Residuals from other capital - K2		13.400	-	-	-	13.400	-	-	-	-	-	13.400	1.700	15.100
	Controlled landfills & other waste storage - L		0.100	-	-	-	0.100	-	-	-	-	-	0.100	4.000	4.100
	Total residuals from material stocks - S=C2+K+L		15.900	-	-	-	15.900	-	-	-	-	-	15.900	6.700	22.600
	Total socio-economic system - H=I+C+K+L=T+S - all materials		23.600	28.500	10.000	38.500	52.100	- 34.000	157.500	123.500	41.200	174.700	226.800	543.000	769.800
	Natural environment	Natural resources - N	270.000	-	-	-	270.000	-	-	-	-	-	270.000	-	270.000
Ecosystem inputs - E		368.000	57.000	-	57.000	425.000	-	-	-	-	-	425.000	-	425.000	
Residuals - W		0.100	-	-	-	0.100	-	-	-	-	-	0.100	-	0.100	
Natural environment - NE (All materials - N+E+W)		638.100	57.000	-	57.000	695.100	-	-	-	-	-	695.100	-	695.100	
TOTAL MATERIAL USE BY ACTIVITY - H+NE		661.700	85.500	10.000	95.500	747.200	- 34.000	157.500	123.500	41.200	174.700	921.900	543.000	1,464.900	
Balance (material accumulation by the activity)		-	-	6.600	6.600	-	- 34.000	142.400	108.400	37.100	152.100	152.100	- 152.100		

Even if they lose their economic value gradually, consumer durables and capital goods remain in the respective kinds of stocks of accumulated material until disposed of. Consumer durables are discarded at some point in time. When they are, a corresponding entry of residuals appears in the column entitled to consumer durables in the supply table. Most of these residuals go to the waste management industry and therefore will be recorded as inputs of residuals to production in the use table. A certain quantity of end-of-life consumer durables may also be dumped directly to nature, and will appear in the natural environment column of the use and of the input output table for residuals.

As already noted, besides capital formation, valuables should also be considered in principle. However the direct contribution of their flows to the socio-economic material metabolism is usually so small that it can be overlooked.

Since there is no flow of products from other capital, gross and net additions to capital stocks other than inventories coincide as far as products are concerned. The other capital column of the supply table and the other capital row of the IO table however are not empty, since there are residual flows from these stocks, such as e.g. demolition waste. Therefore it is not possible to omit them, while it is possible to omit the inventories column of the supply table and the other capital row of the IO table when inventories are recorded as net uses (inventory changes).

When the flows of inventories are accounted for in net terms the figures under the *total capital formation* column headings in the use table and in the PIOT concern only products. These figures are therefore fully coherent with the corresponding monetary values provided by national accounts.

#### 4.8. Example PSUTs

Table 3.11 shows how the individual materials and kinds of materials contribute to the total use of materials by activity. For natural resources this table shows that these materials are used directly by production only, without – for the moment – any further specification. For ecosystem inputs it shows that they are used directly by production and final consumption. The *all products* and *all residuals* rows of the use table are identical to the respective last rows of the two specialised PIOTs shown above. E.g. for products, the *all products* row, which is given by the sum of the 7 preceding rows, is identical to the last row of Table 3.8. The grey background cells provide information that was present in Table 3.5 and cannot change as a consequence of the greater breakdown by activity of the transformation and accumulation subsystems since it concerns flows between the socio-economic system and the natural environment. The only additional information at this aggregation level is on *which* entities of the socio-economic system directly take materials from the natural environment.

**Table 3.11: Example material use table with activities of the socio-economic system subdivided according to economic and physical categories and net changes for inventories**

Use	Socio-economic system											Natural environment NE	TOTAL USE BY MATERIAL H+NE	
	Industries I	Households' final consumption			Total material transformation T=C1	Capital formation			Controlled landfills & other waste storage L	Total material stocks S=C2+K+L	Total socio-economic system H1=C+K+L =T+S			
		Current final material consumption C1	Consumer durables C2	Total households' final consumption C=C1+C2		Inventories change K1	Other capital K2	Total capital formation K=K1+K2						
Natural resources	N1 - Fossil fuels N2 - Ferrous metal ores N3 - Non-ferrous metal ores N4 - Industrial minerals N5 - Construction minerals N6 - Non-cultivated biomass N7 - Water N - All natural resources	65.000 5.000 25.000 15.000 140.000 5.000 15.000 270.000	- - - - - - - -	- - - - - - - -	65.000 5.000 25.000 15.000 140.000 5.000 15.000 270.000	- - - - - - - -	- - - - - - - -	- - - - - - - -	- - - - - - - -	- - - - - - - -	65.000 5.000 25.000 15.000 140.000 5.000 15.000 270.000	- - - - - - - -	65.000 5.000 25.000 15.000 140.000 5.000 15.000 270.000	
Ecosystem inputs	E1 - Water absorbed by cultivated plants and animals E2 - Oxygen for combustion and respiration E3 - CO2 and nutrients for cultivated plants E - All ecosystem inputs	25.000 278.000 65.000 368.000	- 57.000 - 57.000	- - - 57.000	25.000 335.000 65.000 425.000	- - - -	- - - -	- - - -	- - - -	- - - -	25.000 335.000 65.000 425.000	- - - -	25.000 335.000 65.000 425.000	
Products	P1 - Animal and vegetable products P2 - Stone, gravel and building materials P3 - Energy commodities P4 - Metals, machinery, etc. P5 - Plastic and plastic products P6 - Wood, paper, etc. P7 - Water, chemicals and other commodities P - All products	- - - - - - - -	9.500 - 15.500 0.500 1.000 1.000 1.000 28.500	3.500 - - 1.500 1.000 2.000 2.000 10.000	13.000 - 15.500 2.000 2.000 3.000 3.000 38.500	9.500 - 15.500 0.500 1.000 1.000 1.000 28.500	-8.000 -5.000 -15.000 -2.000 -2.000 1.500 -3.500 -34.000	1.000 144.000 - 5.500 2.000 2.000 3.000 157.500	-7.000 139.000 -15.000 3.500 - 3.500 -0.500 123.500	- - - - - - - -	-3.500 139.000 -15.000 5.000 1.000 5.500 1.500 133.500	6.000 139.000 0.500 5.500 2.000 6.500 2.500 162.000	- - - - - - - -	6.000 139.000 0.500 5.500 2.000 6.500 2.500 162.000
Residuals	W1 - GHGs, acidifying substances, ozone layer depleters W2 - Heavy metals to air W3 - Other toxic substances to air (POPs, PCBs, etc.) W4 - Other gaseous residuals (vapour, oxygen, etc.) W5 - Nutrients to water W6 - Heavy metals to water W7 - Other water-polluting residuals (oil spills, solid waste etc.) W8 - Hazardous waste W9 - Construction and demolition waste W10 - Other non-hazardous waste W11 - Manure, sewage, residual water W - All residuals	- - - - - - 0.200 2.300 11.300 7.900 2.000 23.700	- - - - - - - - - - - -	- - - - - - - - - - - -	- - - - - - 0.200 2.300 11.300 7.900 2.000 23.700	- - - - - - 0.200 2.300 11.300 7.900 2.000 23.700	- - - - - - - - - - - -	- - - - - - - - - - - -	- - - - - - - - - - - -	- - - - - - - - - - - -	- - - - - - 0.200 13.000 13.000 17.500 17.500 - 41.200 41.200 64.900	288.000 0.020 0.030 215.000 0.940 0.010 1.000 0.500 1.500 20.000 16.000 543.000	288.000 0.020 0.030 215.000 0.940 0.010 1.200 13.500 25.800 45.400 18.000 607.900	
TOTAL MATERIAL USE BY ACTIVITY (all materials = N+E+P+W)		661.700	85.500	10.000	95.500	747.200	-34.000	157.500	123.500	41.200	174.700	921.900	543.000	1,464.900
Unused Materials	U1 - Wild biota U2 - Mining overburden U3 - Soil removal U - All unused	1.000 55.000 40.000 96.000	- - - -	- - - -	1.000 55.000 40.000 96.000	- - - -	- - - -	- - - -	- - - -	- - - -	1.000 55.000 40.000 96.000	1.000 55.000 40.000 96.000	1.000 55.000 40.000 96.000	

Reading the use table by column, we can see the composition by material of the total uses of a given activity, e.g. in our example current final consumption has had a total input of 85.5 Mt of materials, of which 57 Mt of oxygen from the atmosphere for respiration and combustion and 28.5 Mt of products. Going into further detail, we see that the latter were in fact 9.5 Mt of animal and vegetable products, 15.5 Mt of energy products, 0.5 Mt of metal products, and 1 Mt each of plastic, wood and paper and other products. Besides these materials, households used (gross accumulation) 10 Mt of durables.

Reading the table by row, we can see the composition by activity of the total uses of a given material, e.g. in our example wood and paper products, have been used by households (3 Mt of which 1 Mt in current consumption goods and 2 Mt in durables), by inventories (1.5 Mt as net use) and by other capital (2 Mt). It can be noted that for all other products the inventories have rather played a role of net supplier than of net user (i.e. net uses are negative). Hazardous waste has been used by production (2.3 Mt), stored in landfills (10.7 Mt) and discharged in the natural environment (0.5 Mt) for a total of 13.5 Mt.

Table 3.12 shows how the individual materials and kinds of materials contribute to the total supply of materials by activity and to unused flows (we omitted the latter information from the use table to avoid repetition). For natural resources and ecosystem inputs this table shows nothing more than these materials are supplied by the natural environment. The *all products* and *all residuals* rows of the supply table, transposed, are identical to the respective last columns of the two PIOTs shown above (but for the omission of the *inventories* heading from the supply table where all entries would have been null). E.g. for residuals, the *all residuals* row, which is given by the sum of the 11 previous rows, is identical to the last column of Table 3.9.

**Table 3.12: Example material supply table with activities of the socio-economic system subdivided according to economic and physical categories**

Supply		Socio-economic system									Natural environment NE	TOTAL SUPPLY BY MATERIAL H+NE
		Industries I	Households' final consumption			Total material transformation T=I+C1	Total capital formation K	Controlled landfills & other waste storage L	Total material stocks S=C2+K+L	Total socio- economic system H1=I+C+K+L =T+S		
			Current final material consumption C1	Consumer durables C2	Total households' final consumption C=C1+C2							
Natural resources	N1 - Fossil fuels	-	-	-	-	-	-	-	-	-	65.000	65.000
	N2 - Ferrous metal ores	-	-	-	-	-	-	-	-	-	5.000	5.000
	N3 - Non-ferrous metal ores	-	-	-	-	-	-	-	-	-	25.000	25.000
	N4 - Industrial minerals	-	-	-	-	-	-	-	-	-	15.000	15.000
	N5 - Construction minerals	-	-	-	-	-	-	-	-	-	140.000	140.000
	N6 - Non-cultivated biomass	-	-	-	-	-	-	-	-	-	5.000	5.000
	N7 - Water	-	-	-	-	-	-	-	-	-	15.000	15.000
<b>N - All natural resources</b>		-	-	-	-	-	-	-	-	-	<b>270.000</b>	<b>270.000</b>
Ecosystem inputs	E1 - Water absorbed by cultivated plants and animals	-	-	-	-	-	-	-	-	-	25.000	25.000
	E2 - Oxygen for combustion and respiration	-	-	-	-	-	-	-	-	-	335.000	335.000
	E3 - CO2 and nutrients for cultivated plants	-	-	-	-	-	-	-	-	-	65.000	65.000
	<b>E - All ecosystem inputs</b>		-	-	-	-	-	-	-	-	-	<b>425.000</b>
Products	P1 - Animal and vegetable products	6.000	-	-	6.000	-	-	-	6.000	-	-	6.000
	P2 - Stone, gravel and building materials	139.000	-	-	139.000	-	-	-	139.000	-	-	139.000
	P3 - Energy commodities	0.500	-	-	0.500	-	-	-	0.500	-	-	0.500
	P4 - Metals, machinery, etc.	5.500	-	-	5.500	-	-	-	5.500	-	-	5.500
	P5 - Plastic and plastic products	2.000	-	-	2.000	-	-	-	2.000	-	-	2.000
	P6 - Wood, paper, etc.	6.500	-	-	6.500	-	-	-	6.500	-	-	6.500
	P7 - Water, chemicals and other commodities	2.500	-	-	2.500	-	-	-	2.500	-	-	2.500
	<b>P - All products</b>		<b>162.000</b>	-	-	<b>162.000</b>	-	-	-	<b>162.000</b>	-	-
Residuals	W1 - GHGs, acidifying substances, ozone layer depleters	239.000	48.000	-	48.000	287.000	-	1.000	1.000	288.000	-	288.000
	W2 - Heavy metals to air	0.020	-	-	-	0.020	-	-	-	0.020	-	0.020
	W3 - Other toxic substances to air (POPs, PCBs, etc.)	0.030	-	-	-	0.030	-	-	-	0.030	-	0.030
	W4 - Other gaseous residuals (vapour, oxygen, etc.)	183.240	27.760	1.000	28.760	211.000	-	3.000	4.000	215.000	-	215.000
	W5 - Nutrients to water	0.800	0.140	-	0.140	0.940	-	-	-	0.940	-	0.940
	W6 - Heavy metals to water	0.010	-	-	-	0.010	-	-	-	0.010	-	0.010
	W7 - Other water-polluting residuals (oil spills, solid waste etc.)	0.900	0.100	-	0.100	1.000	-	0.100	0.100	1.100	0.100	1.200
	W8 - Hazardous waste	11.100	1.400	0.500	1.900	12.500	0.500	-	1.000	13.500	-	13.500
	W9 - Construction and demolition waste	13.000	-	-	-	13.000	12.800	-	12.800	25.800	-	25.800
	W10 - Other non-hazardous waste	36.900	4.800	1.900	6.700	41.700	1.800	-	3.700	45.400	-	45.400
	W11 - Manure, sewage, residual water	14.700	3.300	-	3.300	18.000	-	-	-	18.000	-	18.000
<b>W - All residuals</b>		<b>499.700</b>	<b>85.500</b>	<b>3.400</b>	<b>88.900</b>	<b>585.200</b>	<b>15.100</b>	<b>4.100</b>	<b>22.600</b>	<b>607.800</b>	<b>0.100</b>	<b>607.900</b>
<b>TOTAL MATERIAL SUPPLY BY ACTIVITY (all materials = N+E+P+W)</b>		<b>661.700</b>	<b>85.500</b>	<b>3.400</b>	<b>88.900</b>	<b>747.200</b>	<b>15.100</b>	<b>4.100</b>	<b>22.600</b>	<b>769.800</b>	<b>695.100</b>	<b>1.464.900</b>
<i>Balance (material accumulation by activity)</i>		-	-	<b>6.600</b>	<b>6.600</b>	-	<b>108.400</b>	<b>37.100</b>	<b>152.100</b>	<b>152.100</b>	<b>-152.100</b>	
Unused Materials	U1 - Wild biota	1.000	-	-	-	1.000	-	-	-	1.000	1.000	
	U2 - Mining overburden	55.000	-	-	-	55.000	-	-	-	55.000	55.000	
	U3 - Soil removal	40.000	-	-	-	40.000	-	-	-	40.000	40.000	
	<b>U - All unused</b>		<b>96.000</b>	-	-	-	<b>96.000</b>	-	-	-	<b>96.000</b>	<b>96.000</b>

In our example, we can see e.g. that the total 85.5 Mt of products used by the current consumption activity of households have all been transformed into residuals, and precisely into 48 Mt of greenhouse gases and similar air pollutants, 27.76 Mt of water vapour, 0.14 Mt of nutrients emitted directly into environmental waters, 0.1 Mt of other water polluting residuals, 1.4 Mt of hazardous waste, 4.8 Mt of non-hazardous waste, and 3.3 Mt of sewage. No accumulation occurs in this activity as by definition it is distinct from that of consumer durables' purchase and discard. On the contrary, from the durables

stock a quantity of residuals came out (3.4 Mt) that is lower than that (10 Mt) of the newly purchased goods of this kind recorded in the use table, so that a net accumulation of 6.6 Mt by households as consumers occurred.

Reading the table by row, we can also see that the 6.5 Mt of wood and paper products used in the socio-economic system have been supplied (not surprisingly) by production activities. These also supplied 11.1 Mt of hazardous waste of the total 13.5 Mt, the rest of which came from current final consumption (1.4 Mt), dismissal of durables (0.5 Mt) and capital (0.5 Mt).

Supply and use tables such as those just presented are easier to compile than the PIOTs for the individual material kinds and contain much valuable information. In particular, they allow knowing the complete input-output balance of any given activity by juxtaposing the columns of the two tables entitled to it.

Though we introduced them as an intermediary step in the exposition of a more complete and detailed scheme, the PIOTs and PSUTs shown in this section may be used as a reporting scheme on their own, provided they are made more realistic with the introduction of the relations with the rest of the world (see section 6 of the present chapter).

#### 4.9. Further possible subdivisions of accumulation and consumption

Goods going to households as consumers and residuals generated by them could be further distinguished identifying specific consumption purposes according to the specific aims of the accounts, such as for instance own account transport and heating if the focus is on fuel use and/or air emissions. The consumption columns of the PIOTs and the PSUTs may be expanded accordingly. In general, information on households' final consumption should be disaggregated according to the Classification of Individual Consumption by Purpose (COICOP), in order to allow comparison between material inputs and their values by purpose of the consumption activity.

In the cases where government inputs are recorded as final consumption in national accounts, the physical accounts should record government consumption by purpose (according to the COFOG – Classification of Functions of Governments) in a similar way to households' final consumption.

The *other capital* heading could be further subdivided into fixed capital and valuables. The latter contribute very marginally to the material balance in terms of direct flows. Nevertheless, it may be interesting to distinguish them as they usually induce very important indirect flows.

The input flows to capital formation could be further distinguished according to the production purpose for which the goods will be used or by main activity of the purchasing unit. The corresponding columns of the PIOTs and the Use table may be expanded accordingly (it is not necessary to expand those of the supply table nor the economic accumulation row of the IO table, as we do not care for such a detailed distinction of the residuals produced, and it would be too difficult in practice).

## 5. DIFFERENTIATING PRODUCTION ACTIVITIES TO TRACK THE INTERNAL FLOWS OF THE PRODUCTION SUBSYSTEM

In highly functionally differentiated economies, the output of one industry typically serves as input for other industries and the metabolism of an industry also comprises the processing of materials within the production system. Let us now therefore open the black box of production, which is as we have seen the central subsystem in the circulation of matter (not differently from that of value) and look inside it. We will do this by making directly reference to the example tables, as the graphical description of such a system would be exceedingly complicated.

The example tables developed in the present section, which are fully coherent with those shown in the previous sections, introduce greater detail in the accounting scheme in two important respects:

- They show the role of the individual industries in relation to the absorption of natural resources and ecosystem inputs as well as to the generation of products and residuals for production;
- They include details of the flows of products and residuals within the production subsystem.

The first expansion is a fundamental prerequisite for the analysis of the determinants of material flows at the nature-socio-economic system boundary and for the study of the induction of indirect flows. It can be in principle – and often is in practice – carried out without the need that also the second be. Also partial breakdown of inter-industry flows is feasible, e.g. for particular categories of products. These issues are dealt with in greater detail in chapter Chapter 4.

In the example PSUTs and PIOTs of the present section, production activities (industries) are aggregated into four industries: *agriculture, fishing and mining; manufacturing, electricity and construction; waste management and other environmental protection; other services*. The complete headings are therefore as follows:

Socio-economic system													Natural environment	TOTAL MATERIAL SUPPLY BY ACTIVITY		
Industries				Households' final consumption			Capital formation			Controlled landfills & other waste storage	Total material stocks	Total socio-economic system				
Agriculture, fishing and mining	Manufacturing, electricity, construction, etc.	Waste management & other environmental	Other services	Total industries	Current final material consumption	Consumer durables	Total households' final consumption	Total material transformation	Inventories change				Other capital	Total capital formation	L	S=C2+K+L
I1	I2	I3	I4	I=I1+I2+I3+I4	C1	C2	C=C1+C2	T=I+C1	K1	K2	K=K1+K2	L	S=C2+K+L	H=I+C+K+L=T+S	NE	H+NE

Differently from the preceding section, in our example tables for this aggregation level we will also show the internal flows of the individual activities (diagonal cells in the PIOTs). This corresponds to the monetary national accounting standards. Indeed the flows of economic activities are usually surveyed at the entry and exit of smaller entities than the industries (typically at level of the production units described above). Availability of this information is important e.g. for the analysis of transport requirements. The internal flows of a given industry are equal to the sum of the exchanges between the production units that belong to it and would become entirely visible if we expanded the tables as to have one activity for each unit.

### 5.1. Detail by activity

At the most detailed level, the unit involved in production is an establishment. For most firms, there is only one establishment in an enterprise. Both establishments and enterprises can be aggregated to the level of industries. While the difference between establishment and enterprise is important to national accountants, the term "production unit" is used here to mean either of these (as relevant in context) and the term "industry" to mean a group of either. Industries should be classified according to the International Standard Industrial Classification (ISIC) and dealt with in the accounts following national accounting conventions whenever they are applicable.

### 5.2. Roles of the different production activities in the circulation of materials by kind and example PIOTs for products and residuals

#### Flows of natural resources

In general it is not difficult to identify the industries concerned with natural resource extraction because there are only a limited number of industries involved. The most obvious industries, classified according to ISIC Rev. 4 (draft), are:

- 01 Crop and animal production, hunting and related service activities
- 02 Forestry and logging (in particular 023 Gathering of non-wood forest products)
- 03 Fishing and aquaculture

- 05 Mining of coal and lignite
- 06 Extraction of crude petroleum and natural gas
- 07 Mining of metal ores
- 08 Other mining and quarrying.

In our example, these activities belong to the *agriculture, fishing and mining* industry.

Moreover, rock and soil excavated to allow construction works is often used within the same or other construction activities. Unless the excavated materials qualify as residuals (i.e. do not have an economic value to the generator) and therefore their use as recycling, their flows is a direct input of natural resources from nature to the following activities:

- 41 Construction of buildings
- 42 Civil engineering
- 43 Specialized construction activities (soil excavated and used on site)

In our example, these activities belong to the *manufacturing, electricity and construction* industry.

### **Flows of ecosystem inputs**

Ecosystem inputs are used by all production activities. As for oxygen, it is required for combustion processes that take place for example in transport and heating. These processes are instrumental or are carried out as ancillary activities to the main activities of all industries. In these cases they cannot be identified as activities of their own in national accounting, as they do not have an autonomous economic output. As such, also in NMFAcc the ecosystem inputs of these processes or activities have to be recorded as inputs of the activities served by them (main or secondary activities), e.g. the ecosystem inputs – as all other flows – of ancillary transport carried out in agriculture belong to agriculture and not to the transport industry. The transport industry will have its own emissions, to the extent that the provision of transport services (of goods, of persons) is an economic activity in itself. The transport of waste is part of the waste management activities, which include the collection of waste

Another major use of ecosystem input is for the metabolism of cultivated plants. Most of the ecosystem inputs other than oxygen are brought into socio-economic circuits by the cultivation of biological assets (sequestration of carbon from CO<sub>2</sub> for respiration and absorption of water and nutrients). These processes take place mainly in agricultural, animal and forestry production activities.

### **Flows of products**

The use of products as intermediate inputs to production activities as well as the material content of the internal and cross-boundary deliveries of production activities vary sensibly according to the nature of the activity. One important distinction in this respect is between activities producing goods and activities producing services. Apart from the case of electricity (which is an immaterial good) goods always have a material content and the physical flow of the transactions involving them (from the supplier to the user) has a direction that is the same of that recorded in monetary IOTs and opposite than that of money (from the user to the supplier). Services usually do not have a material content or their material content is usually very small.

Services are “economic outputs produced to order and which cannot be traded separately from their production; ownership rights cannot be established over services and by the time their production is completed they must have been provided to the consumers” (it is not important whether the consumers are intermediate or final). The material flows connected to the production of the services have to be considered as flows of the production activity and not of the using one. The latter may however receive, along with the service, materials that are a physical support or object of the service, and that it may store or supply to other units at a later stage, or the provision of the service may entail that the producer take in charge some material thing. The materials transferred (from the

producer of the service to its user, or vice versa) do not constitute in themselves the product exchanged – which otherwise would not be a service but a good. Three cases may be highlighted:

- 1) transport and trade activities, for which two aspects must be systematically distinguished:
  - a. what is bought and sold: a transport of a trade service, not the goods delivered themselves;
  - b. what is entrusted to the transport or sale agent and delivered to the customers;

The only inputs and outputs to be recorded for these activities are those connected to the production of the transport or trade services (e.g. fuel and air emissions for vehicles or heating; packaging not further delivered), not the goods transported or traded. The latter should be shown, in conformity with national accounting practices, as flows directly going from the producing industry to the user (whether intermediate or final). Otherwise we would not see in the production part of the PIOT for products other than flows from and to transport and trade.

- 2) services such as e.g. the provision of a meal in a restaurant. This kind of services resembles manufacturing activities as for the way materials are transformed into them and as for what is delivered to the user. Indeed, there is a material input to the using activity that is contextual to the delivery of the service, while the consequent output of the using activity is not contextual (though it usually happens within the same accounting year). For convenience, this input to the consumption activity can be classified as a product in the most similar category (“animal and vegetable products” or “other commodities” in our example tables). The paper flowing out of photocopy shops provides an example of a similar case, where however the material support is a potentially durable one, as it may be transformed in a residual immediately or stored for long.
- 3) waste and wastewater management services. The peculiarity of this kind of services is that the unit that buys the service in this case pays the producer and gives, rather than takes, materials. This is the only relevant case where a material flow and the corresponding value flow have the same direction. This is further discussed under “flows of residuals” below. It is important to note that waste and wastewater management plays the unique role of transforming part of the residuals generated by production and consumption into products again.

In the example table (Table 3.13) it can be seen that all economic activities use products as intermediate inputs, though to a varying extent. For instance it can be noted that *other services* use much bigger quantities of materials than they provide (remember that the negative value of the change in inventories in the *other services* row means that this industry used up more inventories than it newly stored). It can also be seen that the *waste management and other environmental protection* industry supplies, as a result of recuperation activities, 20.5 Mt of products to the industries (including 1.6 Mt to itself). As usual, information in the grey background cells was already present in the tables presented in the previous section. Some empty rows have been dropped.

The value flows connected to the flows of products to and from production activities are described in monetary IOTs. The complex interdependencies between the different activities that these tables show and the accounting rules that preside to their measurement cannot be resumed here. Reference should be made to the SNA and to current national accounting practices.

**Table 3.13: Example PIOT for products with detail of flows by industry**

Input-output table for Products	Socio-economic system														Natural environment	TOTAL MATERIAL SUPPLY BY ACTIVITY H+NE
	Industries				Households' final consumption			Total material transformation		Capital formation			Total socio-economic system			
	Agriculture, fishing and mining	Manufacturing, electricity, construction, etc.	Waste management & other environmental protection	Other services	Total industries	Current material consumption	Consumer durables	Total households' final consumption	T=I+C1	Inventories change	Other capital formation	Total capital formation	Controlled landfills & other waste storage	Total material stocks		
I1	I2	I3	I4	I=I1+I2+I3+I4	C1	C2	C=C1+C2	T=I+C1	K1	K2	K=K1+K2	L	S=C2+K+L	H=I+C+K+L	H+NE	
Agriculture, fishing and mining - I1	24.200	211.000	3.800	4.400	243.400	3.500	4.500	8.000	246.900	10.600	6.000	16.600	-	21.100	268.000	-
Manufacturing, electricity, construction, etc. - I2	16.800	109.100	14.200	28.800	168.900	23.600	5.500	29.100	192.500	-43.800	151.500	107.700	-	113.200	305.700	-
Waste management & other environmental protection - I3	5.200	13.600	1.600	0.100	20.500	-	-	-	20.500	0.000	-	0.000	-	0.000	20.500	-
Other services - I4	0.800	1.000	0.400	1.700	3.900	1.400	1.400	1.400	5.300	-0.800	-	-0.800	-	-0.800	4.500	-
<b>Total industries - I=I1+I2+I3+I4</b>	<b>47.000</b>	<b>334.700</b>	<b>20.000</b>	<b>35.000</b>	<b>436.700</b>	<b>28.500</b>	<b>10.000</b>	<b>38.500</b>	<b>465.200</b>	<b>-34.000</b>	<b>157.500</b>	<b>123.500</b>	-	<b>133.500</b>	<b>598.700</b>	-
Total households' final consumption - C=C1+C2	-	-	-	-	-	28.500	10.000	38.500	465.200	-34.000	157.500	123.500	-	133.500	598.700	-
Total material transformation - T=I+C1	47.000	334.700	20.000	35.000	436.700	28.500	10.000	38.500	465.200	-34.000	157.500	123.500	-	133.500	598.700	-
Total material stocks - S=C2+K+L	-	-	-	-	-	-	-	-	-	-	-	-	-	-	-	-
<b>Total socio-economic system - H=C+K+L+T+S</b>	<b>47.000</b>	<b>334.700</b>	<b>20.000</b>	<b>35.000</b>	<b>436.700</b>	<b>28.500</b>	<b>10.000</b>	<b>38.500</b>	<b>465.200</b>	<b>-34.000</b>	<b>157.500</b>	<b>123.500</b>	-	<b>133.500</b>	<b>598.700</b>	-
Natural environment - NE	-	-	-	-	-	-	-	-	-	-	-	-	-	-	-	-
<b>TOTAL MATERIAL USE BY ACTIVITY - H+NE</b>	<b>47.000</b>	<b>334.700</b>	<b>20.000</b>	<b>35.000</b>	<b>436.700</b>	<b>28.500</b>	<b>10.000</b>	<b>38.500</b>	<b>465.200</b>	<b>-34.000</b>	<b>157.500</b>	<b>123.500</b>	-	<b>133.500</b>	<b>598.700</b>	-

**Table 3.14: Example PIOT for residuals with detail of flows by industry**

Input-output table for Residuals	Socio-economic system														Natural environment	TOTAL MATERIAL SUPPLY BY ACTIVITY H+NE
	Industries				Households' final consumption			Total material transformation		Capital formation			Total socio-economic system			
	Agriculture, fishing and mining	Manufacturing, electricity, construction, etc.	Waste management & other environmental protection	Other services	Total industries	Current material consumption	Consumer durables	Total households' final consumption	T=I+C1	Inventories change	Other capital formation	Total capital formation	Controlled landfills & other waste storage	Total material stocks		
I1	I2	I3	I4	I=I1+I2+I3+I4	C1	C2	C=C1+C2	T=I+C1	K1	K2	K=K1+K2	L	S=C2+K+L	H=I+C+K+L	H+NE	
Agriculture, fishing and mining - I1	-	-	19.500	-	19.500	-	-	-	19.500	-	-	-	-	-	19.500	154.500
Manufacturing, electricity, construction, etc. - I2	-	15.600	-	-	15.600	-	-	-	15.600	-	-	-	0.500	0.500	163.400	169.500
Waste management & other environmental protection - I3	-	15.800	15.800	-	31.600	-	-	-	15.800	-	-	-	40.700	40.700	66.600	123.100
Other services - I4	-	6.500	-	-	6.500	-	-	-	6.500	-	-	-	-	6.500	103.500	110.000
<b>Total industries - I=I1+I2+I3+I4</b>	<b>-</b>	<b>37.400</b>	<b>35.300</b>	<b>-</b>	<b>72.700</b>	<b>-</b>	<b>-</b>	<b>-</b>	<b>57.400</b>	<b>-</b>	<b>-</b>	<b>-</b>	<b>41.200</b>	<b>41.200</b>	<b>488.500</b>	<b>557.100</b>
Current final material consumption - C1	-	-	7.700	-	7.700	-	-	-	7.700	-	-	-	-	7.700	77.800	85.500
Consumer durables - C2	-	-	2.400	-	2.400	-	-	-	2.400	-	-	-	-	2.400	3.400	3.400
<b>Total households' final consumption - C=C1+C2</b>	<b>-</b>	<b>-</b>	<b>10.100</b>	<b>-</b>	<b>10.100</b>	<b>-</b>	<b>-</b>	<b>-</b>	<b>10.100</b>	<b>-</b>	<b>-</b>	<b>-</b>	<b>-</b>	<b>10.100</b>	<b>88.900</b>	<b>92.300</b>
Total material transformation - T=I+C1	-	-	65.100	-	65.100	-	-	-	65.100	-	-	-	41.200	41.200	642.600	743.900
Inventories - K1	-	-	-	-	-	-	-	-	-	-	-	-	-	-	-	-
Other capital - K2	-	-	13.400	-	13.400	-	-	-	13.400	-	-	-	-	-	13.400	15.100
<b>Total capital formation - K=K1+K2</b>	<b>-</b>	<b>-</b>	<b>13.400</b>	<b>-</b>	<b>13.400</b>	<b>-</b>	<b>-</b>	<b>-</b>	<b>13.400</b>	<b>-</b>	<b>-</b>	<b>-</b>	<b>-</b>	<b>13.400</b>	<b>15.100</b>	<b>15.100</b>
Controlled landfills & other waste storage - L	-	-	0.100	-	0.100	-	-	-	0.100	-	-	-	0.100	0.100	4.100	4.100
Total material stocks - S=C2+K+L	-	-	15.900	-	15.900	-	-	-	15.900	-	-	-	-	15.900	22.600	22.600
<b>Total socio-economic system - H=C+K+L+T+S</b>	<b>-</b>	<b>-</b>	<b>81.000</b>	<b>-</b>	<b>81.000</b>	<b>-</b>	<b>-</b>	<b>-</b>	<b>81.000</b>	<b>-</b>	<b>-</b>	<b>-</b>	<b>41.200</b>	<b>122.200</b>	<b>665.200</b>	<b>743.900</b>
Natural environment - NE	-	-	0.100	-	0.100	-	-	-	0.100	-	-	-	-	0.100	0.100	0.100
<b>TOTAL MATERIAL USE BY ACTIVITY - H+NE</b>	<b>-</b>	<b>-</b>	<b>81.100</b>	<b>-</b>	<b>81.100</b>	<b>-</b>	<b>-</b>	<b>-</b>	<b>81.100</b>	<b>-</b>	<b>-</b>	<b>-</b>	<b>41.200</b>	<b>122.300</b>	<b>665.300</b>	<b>744.000</b>

## **Flows of residuals**

The new information provided by the breakdown by industry of residual flows is very interesting both for the aspect of the composition by supplying industry of the residuals supplied by the production subsystem as a whole to landfills and the natural environment – and for the aspect of the internal flows of this subsystem. Because of the interest of this information from the environmental point of view, the development of partial tables for residuals constitutes a very common and fruitful approach to physical accounting (Chapter 4).

Residuals should in all cases be attributed to the production activity directly responsible for the residual generation. Thus pollution generated from electricity production should be attributed to electricity suppliers and not to the electricity consumers. The direct recording of residual flows is important for accurate and consistent connection of residual flows to material throughputs and economic transactions, and hence linking pollution generation to final uses. The attribution of pollution to final users or products is an analytical continuation of accounting, based on the concept of indirect flows.

All production activities generate residuals. What has been said above under the “ecosystem inputs” heading about combustion processes is clearly valid also for the generation of air emissions by the activities. In particular, the treatment of emissions from transport processes should be coherent with that of the use of ecosystem inputs in the same processes. The production of services, and more precisely the consumption of goods as intermediate inputs in service activities, produces residuals, for example the tailpipe emissions from a bus that is powered with diesel fuel. The consumption of the service in general generates little in the way of residuals except, for example, a bus ticket thrown away by the passenger. In the case of goods, not only their production, but also their final consumption and discard generates residuals.

### ***Waste management and recycling***

There are mainly two types of economic activities that may result in the absorption of residual flows within the economic system: recycling and waste (water) collection and treatment. The case of these activities is a peculiar one, as they have residuals as an object of work. In managing residuals, they produce residuals in their turn in two different ways: not only like all other activities by using products as intermediate inputs for the functioning of its machinery etc. but also as a result of the transformation or further delivery of the object of work itself. Moreover, it produces products out of residuals.

To the extent that they do not transform the residuals, but only collect, transport and store them in landfills or otherwise dispose of them without combination with other materials, waste management activities resemble transport and trade activities. To this extent, residuals could be considered as not being absorbed by waste management but directly delivered to their final destination by generating production and consumption activities. In this case only waste actually transformed would appear – besides the operating inputs of products – as input of waste management activities. This would enhance the information content of PSUTs and PIOTs eliminating some double counting. However, the necessary data may not be available. The choices made in the accounting treatment of residuals should always be declared.

Economic activities specifically involved in the recycling of material flows are recycling industries (ISIC 37) and wholesale trade in waste and scrap (ISIC 5149). The main activity of recycling industries consists of the mechanical or chemical transformation of materials in order to make these usable again as industrial inputs. The activity of wholesale trade in waste and scrap is restricted to waste storage, sorting etc. and is one where goods are sold in the same condition in which they are acquired without undergoing any physical transformation other than sorting, and packaging. If any industry, recycling or wholesale, acquires inputs at zero (or near zero) cost, the inputs should be regarded as inputs of

residuals. If the inputs for recycling have a positive price, then they should be treated as products and recorded as such.

Residuals for recycling typically follow one of two paths. Material which can be recycled without further handling, for example paper, often passes through wholesalers to the user. Material which needs processing typically reaches the wholesaler only after it has been converted to "secondary raw material" by the processors.

In the case where a wholesaler also processes residuals into usable material, special treatment in the accounts may be needed. Under national accounts conventions, wholesalers are not shown as acquiring and disposing of goods but only of adding a trade margin. The goods are shown as going directly from the producer to the user and do not feature as intermediate consumption of the wholesaler. It is desirable to vary this practice in respect of residual handling for the part of residuals that the wholesaler acquires and processes leaving a smaller quantity remaining as residuals.

Another example of residuals retained in the economy is the collection and treatment of waste or waste water by environmental services. The main purpose of these services is to reduce the environmental impact of residual flows for example by treatment of hazardous waste or purification of wastewater. Waste (water) treatment in these services will subsequently lead to different and hopefully less harmful types of residual outputs.

In our example table (Table 3.14), we have collected all waste management activities – and therefore waste inputs to production – in a single industry. As a consequence, this industry – which in the example comprises recycling – appears as the only one using residuals. It should be kept in mind however that in the real world often this kind of activity is carried out as a secondary or even ancillary activity in other industries. In the example, *waste management and other environmental protection* received from all activities 81 Mt of waste and wastewater (including 15.8 from itself) and – as already seen in Table 3.13 – it recovered from them 20.5 Mt of useful materials (products). Of the remaining 60.5 Mt, only 41.2 have been landfilled or temporarily stocked. The rest – there is no other possibility – must have been incinerated. However, the emissions of waste management to the environment are much higher of the non-recovered non-landfilled quantity not just because of the combustion of waste but also of the fuels used in the sector to run all waste collection and treatment processes.

### Flows of unused materials

Flow of unused materials occur in the production processes of the primary sector, whose basic function is to separate useful materials from the rest of nature and made them available for the use of man, while moving out of the way the materials which may hinder the access to the wanted materials. A similar thing happens in construction works where rock and soil are excavated for laying basements and for shaping the surface of the earth as needed for roads and other infrastructure. As already noted part of these materials may be used, and this part should clearly not be counted as unused.

Like with natural resource extraction, it is not difficult to identify the activities that directly move materials without using them. The most obvious industries, classified according to ISIC, are the same as the extracting industries enumerated above.

### 5.3. Example PSUTs

Table 3.15 and Table 3.16 show the example PSUTs corresponding to this aggregation level. With respect to Table 3.11 and Table 3.12 there is no change for the entities which we did not further disaggregate, while the total flows of products and residuals now visible for the whole industries, transformation and socioeconomic system increased because we opened the black box of industries.





## 6. INTRODUCING THE REST OF THE WORLD (ROW) IN THE ACCOUNTING FRAMEWORK: THE FULL-FLEDGED NMFACC SCHEME

In the present section we remove our focus country from the glass bowl and put it in the real world, where trade flows between different countries are an important fact and becoming more and more important. In order to allow the description of these flows, we introduce two last distinctions in our scheme, between the rest of the world (RoW) socio-economic system and environment on the one hand and the national socio-economic system and environment on the other hand.

From a materials use point of view, the international exchange of goods and services changes the picture radically because it allows the individual countries to have uses of products different from their production. Commodities flow from one country to the other at all degrees of elaboration, which implies a certain degree of independence between the composition of final and intermediate consumption on the one hand and that of production on the other hand. This in turn implies independence between the use of natural resources on the one hand and the generation of environmental pressures on the other hand. Moreover, to the extent that also waste management services are traded internationally and residuals flows from one national environment to the other, there also is a certain independence of a country's generation of residuals from their absorption by that country's environment.

The relative independence of pressures generation from natural resources use given by international trade can be also expressed by making reference to the concept of indirect flows. The indirect pressures due to a countries' use of products take place, to the extent that the products are imported, in the countries that supply the goods and services it uses. Similarly, the indirect pressures of the goods and services that a country exports take place in that country's and in its supplying countries' environment.

### 6.1. The residence principle

The boundary of the national socio-economic system is established in relation to production by defining "resident" institutional units, which contribute to national production (residence principle). An institutional unit is said to be resident within the economic territory of a country when it maintains a centre of economic interest in that territory - that is, when it engages, or intends to engage, in economic activities or transactions on a significant scale either indefinitely or over a long period of time, usually interpreted as one year. The national accounts are compiled for resident units (residence principle). As an aggregate measure of production, for instance, the GDP of a country is equal to the sum of the gross values added of all resident institutional units engaged in production (plus any taxes, and minus any subsidies, on products not included in the value of their outputs). This is not exactly the same as the sum of the gross values added of all productive activities taking place within the geographical boundaries of the country. Some of the production of a resident institutional unit may take place abroad. Conversely, some of the production taking place within a country may be attributable to foreign institutional units.

While there is a large overlap between resident units and those located within the geographic boundaries of a country they are not exactly the same. For administrative reasons, an exception is made for embassies, consulates or military bases belonging to foreign countries which are by convention regarded as resident units of their parent country and also for the operations of international organisations on the national territory (1993 SNA, paragraph 4.163). Units intending to operate in a country for less than a year are also regarded as non-resident. These may be specialised construction firms or aid relief agencies, for example.

For the purposes of national MFAcc, it is also important to consider where units operate as well as where they are resident. The majority are resident and operate in the national territory. Some resident units operate abroad. For example transport equipment used for international travel and freight operate a good deal of the time outside the national territory. When this is so, the residuals generated at that time are vented into the environment but not the national environment. The reverse situation occurs also of course. Some forms of transport also absorb ecosystem inputs in the form of air for combustion. Equally fishing vessels operated by non-residents may extract natural resources (legally or illegally) from national waters. Thus there may be both ecosystem inputs and natural resource flowing from the environment of one country to the economy of another.

As for households' activities, tourist activity requires careful consideration. If tourists come on the national territory and use local buses, say, the cause of the pollution generated by the buses may be international tourism but the pollution itself is generated by a national, resident producer, the bus company. If the tourists use their own cars, filled with petrol bought before they cross the border, then this is similar to international transport services; the residuals are generated by units resident in one country into the environment of another.

Applying the residence principle implies that materials purchased or extracted by resident units abroad have to be considered inputs as well as emissions abroad would have to be considered outputs of the target economy. In the same way, materials extracted or purchased by non-residents on a nation's territory (and correspondingly emissions and wastes) have to be subtracted from the target nation's material flow account. These flows however are likely to be of minor importance from the point of view of material flows.

In principle, the use of products by embassies etc. located in the national economy should be treated as exports and consumption in the country's own embassies abroad should be treated as imports. An allowance for this is made in monetary terms in the balance of payments calculations and in the national accounts but it may not be possible to make a similar adjustment in physical terms. Any error caused by this would normally be well within the margin of error on the whole exercise.

In a similar way, adjustments for the purchase of products by tourists in the national economy and by nationals abroad are made in monetary terms and should be made in physical terms. It may not always be practical to determine how much foreign tourists contribute to the residuals generated in a country and if it is thought that the flows in from foreign tourists approximately balance the flows out by residents travelling abroad, it may be acceptable to ignore this. For countries where tourism is a major net contributor to the economy, though, it will be highly desirable to estimate what the contribution to national residual generation by tourists is, both when using non-resident facilities (foreign airlines, say) and when using national facilities (for example the demand for water in hotels). This is especially important for fuel in the case of countries with land borders where many tourists come using their own cars or in home country buses.

## 6.2. Overview of material flows between national and RoW systems

The application of the residence principle to production further specifies the boundary of our focus system, cross-cutting that given by the distinction between socio-economic system and natural environment. It is important to note that the union of these two entities no longer constitutes a closed system as far as material flows are concerned, as now materials can be exchanged between units resident in different countries. The main difference with the "glass bowl" system is in fact given by the appearance of trade flows. Imported and exported goods as well as the possible material content of some services (e.g. restoration of tourists) are respectively inputs and outputs for national human activities, respectively supplied and used by the RoW socio-economic system. Expenditures by residents abroad constitute imports, while expenditures by non-residents are exports.

Figure 3.4, which is a graphic translation of the I/O scheme of Table 3.1, summarises the most important flows to be represented in the tables as far as the relationships with the RoW are

concerned. Only the flows between the national socio-economic system and the other systems are shown.

Natural resources and ecosystem inputs used by the national socio-economic system come both from the national and from the RoW environment. Because natural resources are converted to products when they enter an economy, few natural resources are shown as entering the national economy from another country's environment directly (flow NR RoW in the figure); such resources are generally routed through the originating country's economy (flow NRn) and are shown as imports of products rather than of natural resources. One exception is fish where non-residents may be entitled to fish in national waters without the catch ever entering the national economy. Another is extraction of water from a jointly owned catchment area or watercourse.

The largest and most obvious flows of ecosystem inputs are from the national environment to the national socio-economic system (EIn). Other flows include the consumption of ecosystem inputs by resident producers and consumers operating outside their national territory, for example international transport carriers and tourists (EI RoW, e.g. use of oxygen for combustion drawn from a foreign environment by national vessels operating outside their own territory).

**Figure 3.4: Material flows between the national socio-economic system and natural environment with the RoW systems**

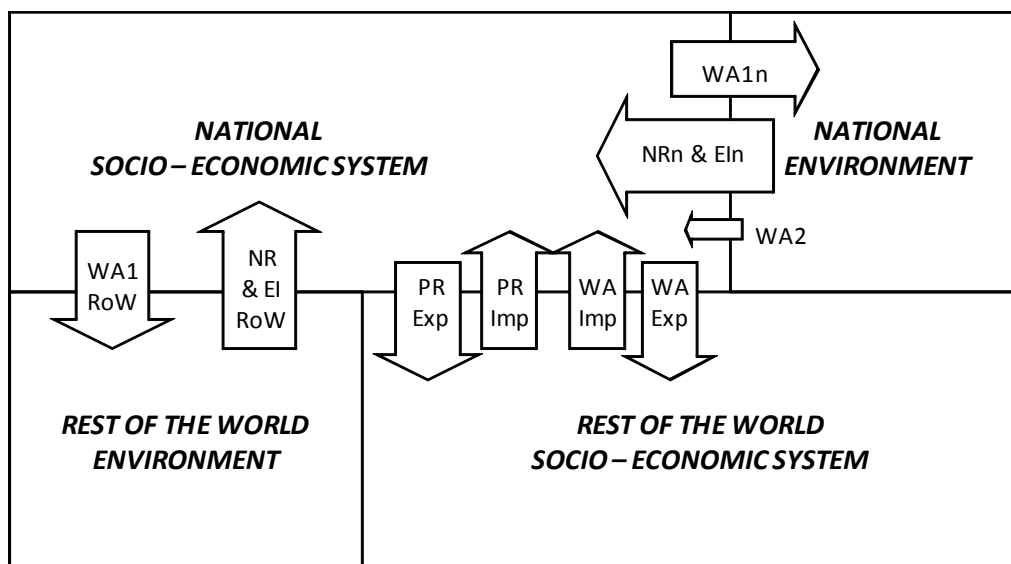

Products come from industries or the RoW (imports) and are used by the national socio-economic system or exported. As long as we are considering only those flows which cross one of the boundaries demarcating either socio-economic system and environment or nation and rest of the world, the only product flows to be recorded are those which constitute imports and exports, that is flows from the national economy to the rest of the world socio-economic system or vice versa, from the foreign economy to the national rest of the world (PR Imp and PR Exp).

Residuals generated by the national socio-economic system are either retained within the national or RoW socio-economy system to be recycled into products or stored in landfill sites or are "used" by, that is, discharged into the national or RoW environment or exported to the RoW economy. The largest and most significant residuals flows are from the national economy to the national environment (WA1n). Resident units, both operating in the country and abroad, may deliver their residuals to the waste management services of another country (WA Exp); discharge from national production and consumption activities is also made directly into a different environment (WA1 RoW).

Residuals generated by the RoW socio-economic system are considered here only insofar as they enter the national economy. Non-residents units may deliver their residuals to the waste management

services of the focus country (WA Imp). International movements of residuals (waste) may take place both legally and illegally. In these cases usually a waste management service is sold from one country to another. Residuals withdrawn from the RoW environment by the national socio-economic system may exist; however though in the figure they are not shown as they are likely to be a very minor item.

Transmission of residuals from one environmental sphere to another happens by natural mechanisms – for example, residuals carried in air currents or flowing water bodies. These flows, as well as the direct emissions of non residents in the national environment, are not part of our focus flows and we therefore do not report them in our example tables nor included them in Figure 3.4, but they also should be taken into account in if the emphasis is on total flows to and from the national environment<sup>14</sup>.

### **6.3. Treatment of the RoW socio-economic system and environment**

#### **6.3.1 The RoW socio-economic system**

The introduction of the rest of the world socio-economic system in the accounting scheme is conceptually very simple, whatever the level of aggregation of the starting scheme, so that in principle a scheme considering the rest of the world could be formulated starting from any of the aggregation levels considered so far. An additional heading is introduced in the scheme, under which flows concerning the rest of the world socio-economic system are reported, i.e. materials exchanged through imports and exports of goods and services, through use of products by non residents on the national territory and of residents abroad and through shipping of residuals for treatment and disposal.

Most of the materials that cross the national boundary are products, and more precisely goods. These should be classified according to the same classification used for the products of the national economy. The rest of the world behaves in a very similar way to the inventories as far as the products are concerned: it absorbs products from the national industries and gives products to national industries and households.

#### **6.3.2 The RoW environment**

The rest of the world natural environment can be dealt with simply by splitting the environment headings in the SU and IO tables into two headings, one for the national environment and one for the rest of the world environment. In the tables it becomes thus visible how much of the natural resources and ecosystem inputs used by national production and consumption activities comes from abroad, and how much of the residuals generated by these activities are released to the RoW environment or “exported” to the foreign economy that takes them in charge.

### **6.4. Complete example PSUTs and PIOTs**

Table 3.17, Table 3.18 and Table 3.19 represent the complete final scheme, including flows from the rest of the world socio-economic system to the national one. Flows not involving the national socio-economic system are not reported in the example tables, like in Figure 3.4.

---

<sup>14</sup> Cross border pollution transfers are important for determining the total net accumulation of residuals in the national environment and are especially relevant for pollutants related to environmental degradation problems which are of a non-global nature.





Table 3.19: Complete example aggregate PIOT

		Socio-economic system													Natural environment			TOTAL MATERIAL USE BY ACTIVITY - <i>H+NE</i>			
		National socio-economic system													Rest of the world socio-economic system						
National socio-economic system		Industries				Households' final consumption				Capital formation			Total national socio-economic system		Rest of the world socio-economic system		National environment				
		Manufacturing, electricity, construction, etc.		Waste & wastewater management		Consumer durables		Total household final consumption		Other capital formation		Total material transformation		Total national socio-economic system		National environment		Rest of the world environment			
		I1	I2	I3	I4	C1	C2	C2	C1+C2	K1	K2	K+K1+K2	L	S-C2+K+L	H1+I+S	H2	H+H2	NE1	NE2	NE+NE2	
Agriculture, fishing and mining - I1		24.200	211.000	23.300	4.400	262.900	2.500	4.500	7.000	- 0.200	6.000	5.800	-	10.300	275.700	20.400	296.100	132.500	2.500	135.000	431.100
Manufacturing, electricity, construction, etc. - I2		16.800	109.100	26.300	20.300	172.500	18.100	5.000	23.100	- 10.000	149.500	139.500	-	144.500	335.100	51.000	386.100	151.600	1.800	153.400	539.500
Waste & wastewater management - I3		5.200	13.600	17.400	0.100	36.300	-	-	-	-	-	-	39.500	39.500	75.800	0.700	76.500	66.600	-	66.600	143.100
Other services - I4		0.800	1.000	6.900	1.700	10.400	1.400	-	1.400	0.100	-	0.100	-	0.100	11.900	0.600	12.500	93.190	10.310	103.500	116.000
Total Industries - I=I1+I2+I3+I4		47.000	334.700	73.900	26.500	482.100	22.000	9.500	31.500	- 10.100	155.500	145.400	39.500	194.400	698.500	72.700	771.200	443.890	14.610	458.500	1,229.700
Households' final consumption - C1		-	-	7.200	-	7.200	-	-	-	7.200	-	-	-	-	7.200	0.500	7.700	72.410	5.390	77.800	85.500
Consumer durables - C2		-	-	2.400	-	2.400	-	-	-	2.400	-	-	-	-	2.400	-	2.400	1.000	-	1.000	3.400
Total households' final consumption - C=C1+C2		-	-	9.600	-	9.600	-	-	-	9.600	-	-	-	-	9.600	0.500	10.100	73.410	5.390	78.800	88.900
Total material transformation - T=H+C1		47.000	334.700	81.100	26.500	489.300	22.000	9.500	31.500	- 10.100	155.500	145.400	39.500	194.400	705.700	73.200	778.900	516.300	20.000	536.300	1,315.200
Capital formation - K		-	-	13.100	-	13.100	-	-	-	-	-	-	-	-	13.100	-	13.100	1.700	-	1.700	14.800
Controlled landfills & other waste storage - L		-	-	0.100	-	0.100	-	-	-	0.100	-	-	-	-	0.100	-	0.100	4.000	-	4.000	4.100
Total material stocks - S=C2+K+L		-	-	15.600	-	15.600	-	-	-	-	-	-	-	-	15.600	-	15.600	6.700	-	6.700	22.300
Total national socio-economic system - H=I+S		47.000	334.700	96.700	26.500	504.900	22.000	9.500	31.500	- 10.100	155.500	145.400	39.500	194.400	721.300	73.200	794.500	523.000	20.000	543.000	1,337.500
Rest of the world socio-economic system - H2		8.600	64.300	3.800	10.000	86.700	6.500	0.500	7.000	3.000	2.000	5.000	-	5.500	98.700	11.000	109.700	-	-	-	109.700
Total socio-economic system - H+H2		55.600	399.000	100.500	36.500	591.600	28.500	10.000	38.500	- 7.100	157.500	150.400	39.500	199.900	820.000	84.200	904.200	523.000	20.000	543.000	1,447.200
National environment - NE1		373.500	138.900	42.600	71.600	626.600	53.500	-	53.500	680.100	-	-	-	-	680.100	-	680.100	-	-	-	680.100
Rest of the world environment - NE2		2.000	1.600	-	7.900	11.500	3.500	-	3.500	15.000	-	-	-	-	15.000	-	15.000	-	-	-	15.000
Total natural environment - NE+NE2		375.500	140.500	42.600	79.500	638.100	57.000	-	57.000	695.100	-	-	-	-	695.100	-	695.100	-	-	-	695.100
TOTAL USE BY ACTIVITY - H+S		431.100	539.500	143.100	116.000	1,229.700	85.500	10.000	95.500	- 7.100	157.500	150.400	39.500	199.900	1,515.100	84.200	1,599.300	523.000	20.000	543.000	2,142.300
Balance (material accumulation by the activity)		-	-	-	-	-	-	6.600	6.600	- 7.100	142.700	136.600	35.400	177.600	177.600	- 25.600	152.100	- 157.100	5.000	- 152.100	-

For the sake of simplicity in the reading of the example tables, the figures used have been left as much as possible unchanged. Although it is very unlikely that a national system giving up autarchy to participate to international trade would keep the quantities of its exchanges with nature unaltered, it may be noticed that this would not be the case if – up to the moment of opening the market – the imports and exports were substituted by withdrawals from and additions to the inventories. However unlikely, we can imagine this to be the case of our example country: indeed the changes in inventories of the glass-bowl-country example can be obtained by subtracting the balance between imports and exports of products from the value of inventories in the complete example (this holds also by kind of product). Besides foreign trade of products we introduced some import-export in residuals, which influences the overall balance of the exchanges of the rest of the world with the national system. We did not include any transit goods in the example tables, but this could be easily done by adding the same values to the national system's imports and to its exports (by kind of good or residual) in the PSUTs and filling in the RoW-RoW cell in the PIOT with the total of these values (these operations would of course not influence the trade balance).

### **6.5. Subdivision of material flows into transformation chains and balanced PIOTs by transformation chain**

There are many different possible ways of identifying subsystems of a whole national economy. A particularly interesting one has been used in order to develop the numerical example presented in the present chapter. This has been designed by compiling separately the whole set of PIOTs for the individual materials of our coarse classifications (i.e. 7 for natural resources, 3 for ecosystem inputs, 7 for products and 11 for residuals and 3 for unused materials) for 5 different and separated "transformation chains" (fossil fuels; metals and metal products; construction minerals; wood and food; chemicals, pottery, glass etc.;) which together give the whole of our imaginary country's material flows.

These "transformation chains" have been identified by ideally following the flow of the materials contained in one or two individual items of our example classification of natural resources (e.g. metal ores) through the socio-economic system and including in the transformation chain the ancillary material flows that are strictly connected to the transformation of the focus resource into products and residuals. By "strictly connected" we mean here that they physically enter the transformation of the resource, being mixed and bound with it or resulting from its transformation (e.g. the coke used in smelting is included in the metal products transformation chain, but not the other fuels consumed to provide energy for the process: these have been assigned to the fossil fuels transformation chain; CO<sub>2</sub> and slag from the smelting process).

Such a delimitation of the transformation chain defines a closed material system, that does not physically receive materials from other transformation chains nor gives any to them, even though functional relationships exist between the transformation chains. E.g. the transformation of fossil fuels is functional to all other socio-economic activities, but the material balance of combustion processes and of the making and use of plastic is kept separate from the other balances. To the subsystems thus identified, the complete accounting scheme can be applied as if it was a country in its own right. This delimitation of the system is orthogonal to the classification of the activities as well as to the classification of the materials by kind, since all materials and activities potentially participate in a resource's cycle, and many materials actually participate in more than one transformation cycles. This is of course the case of our very coarse exemplification classifications, but also is in reality.

The following figure shows the complete input-output table for our example transformation chain concerning collected and produced biomass ("wood and food"). This summarises the individual tables developed for the 3 kinds of natural resources, 3 ecosystem inputs, 3 products and 8 residuals that participate in this transformation chain (ideally including for instance biological metabolism of plants, animals and humans, all kinds of fertilisers and what enters in them, wooden furniture).



## 6.6. Comparing material and monetary aggregates

By definition, only the flows of products represent value flows in themselves (roughly speaking, they have a price), while the flows of environmental resources (natural resources and ecosystem inputs) and residuals do not represent per se flows of value that are recorded in the SNA. However in most cases they may be connected to SNA flows, though in different and less direct ways, because they are at the origin of value flows or are functionally connected to them, e.g. because they enter production processes or because taxes are paid on their use or generation. Almost all material flows can be more or less significantly put in relation to some flows or changes of values. The following considerations provide some examples of the possibilities and problems of establishing such relations for the different kinds of materials.

The physical flow of natural resources can be related to the value of the products resulting from extraction, but it should be clear that – even if no other transformation than extraction itself takes place – these products are, by the simple fact of having been separated from the earth, a different material than the natural resource itself and their value is not the value of the natural resource itself (it corresponds to an internal flow of the economy, that of the product going from the extractor to the user). A better estimate of the value corresponding to the physical flow of extraction is the reduction in value of the reserve of the resource due to the depletion caused by the extraction, which is recorded in the SNA as a change in assets. Conceptually, the most similar thing to a price for the resource are specific taxes and fees paid to the government by the extractor, though they represent only a part of the value. The extraction flow can also be related to the value of the other inputs of the extraction activity, that are used to extract it (e.g. of labour).

Most *ecosystem inputs* do not have any corresponding economic value, not even an indirect one. In principle they could, as for natural resources, be put in relation to the value of the product outputs obtained from them. However the case is not interesting since ecosystem inputs are not seen as being at the origin of economic value, being very abundant. Nothing similar to a price exists for ecosystem inputs, not even in the form of taxes to be paid for their use, with the possible notable exception of negative CO<sub>2</sub> taxes for carbon sequestration (i.e. the quantity used of this ecosystem input may be put in relation to the subsidies, if any are given for sequestering atmospheric carbon).

The physical flows of *products* can be put in relation to the whole range of value flows connected to their being produced and to their being transferred from one unit to another (their own value, the value added of the activity, the taxes and paid by the activity that produces them...). As inputs to productive activities, they can also be put in relation to the value of other inputs (e.g. of labour) or of the products realised thanks to their use (e.g. as to obtain output value per physical input unit or vice versa physical input intensity per unit value).

Data from monetary accounts concerning final consumption – understood as acquisition of products by households – immediately correspond to physical data on this kind of transaction, while there is a certain inconsistency in comparing them with data from physical accounts concerning consumption understood as physical use of the goods resulting in their discard.

Also *residuals* as such do not have a price. However when a residual is exchanged inside the socio-economic system, the service of managing it usually has a price, which can be seen as the negative price of the residual itself. For residuals that flow between the socio-economic system and nature (e.g. CO<sub>2</sub> emissions), their generation may be taxed, and this can also be seen as a negative price. Like for the environmental resources used, the residuals generated by production activities can be put in relation to the monetary flows immediately connected to the respective activities (value added, output value...).

*Unused materials* do not have any immediate counterpart in value flows. They can be put in relation to the value of the outputs obtained in the activities that move them, or to the cost of moving them.

An unavoidable discrepancy between monetary and physical data concerns the exit of capital goods from the useful stocks, which is gradual in value terms but sudden and all-at-once in physical terms.

As seen before in the waste management industry there is a quite uncommon situation. Like other service activities, waste management services present the peculiarity that the main product they sell is not what physically passes between the units involved; but unlike the other cases, where the matter still flows in the same direction as the product and in the opposite direction of the monetary flow, in this case the relation of the material flow to the other flows is inverted. This does not imply difficulties for the comparison of monetary values and physical flows as long as the waste flow is kept distinct from other residual and product flows, as in PIOTs by kind of materials and PSUTs: it is sufficient to consider that what appears as an input to waste management is not something these activities paid for, but on the contrary represents an economic output, as it is something the activities are paid for. However, in an aggregated PIOT (unless the waste flow is kept somehow distinct) the information is mixed up, as the input from other industries results from the sum with the product inputs, i.e. the working inputs necessary for the activity to run (e.g. gasoline for waste collection trucks).

*Chapter 4.***BREAKDOWN BY ACTIVITY OF THE INPUTS AND OUTPUTS OF THE NATIONAL SOCIO-ECONOMIC SYSTEM AND THE CALCULATION OF ITS INDIRECT FLOWS**

The present chapter<sup>15</sup> focuses on the different possible approaches to the breakdown by activity of the flows of the national socio-economic system and to the calculation of indirect flows based on this breakdown.

**1. THE NAMEA APPROACH TO MATERIAL FLOWS AS PARTIAL REALISATION OF THE NMFACC FRAMEWORK**

Production and final consumption activities are the driving force behind the environmentally relevant flows of materials. They command the intake of most materials from the natural environment into the socio-economic system, the use products as inputs in the form of raw materials, semi-manufactures and finished products and generate the residuals stored in landfills and emitted to the environment. A breakdown of the aggregates of the material balance of production and final consumption activities by branches establishes a detailed link to the immediate causes of the flows and allows further analysis of the determinants in terms of indirect causes. To make sure that the detailed material flow data can be combined with the economic data, the disaggregation of the production subsystem should follow the concepts and classification of economic activities that are used in the National Accounts for describing the economic process in monetary terms.

The NMFACC framework presented in Chapter 3, based on complete PSUTs and PIOTs, is the most comprehensive approach possible. As far as flows within the socio-economic system are concerned, the PIOTs mirror the monetary input-output tables (MIOTs), extending them to the flows of residuals. However the most important point is that they show, in addition to these flows, the material flows between the socio-economic system and the environment. As seen, the uses of environmental resources as well as the outputs to the environment (residuals) can be shown in a breakdown by type of material in PIOTs. However calculating PIOTs is costly and the data requirements are rather high and so far similar approaches, considering all flows in a unitary framework, have been put into practice only in rather few cases, and if, only for pilot years.

A much more parsimonious approach is given by the NAMEA (National Accounting Matrix including Environmental Accounts). In general, the EA part of the NAMEA consists in the description of flows of special interest as vectors of variables connected to production and consumption activities (it can be both physical and monetary flows; however here we are only interested in the physical ones). The accounting matrix, which describes the economic interrelationships between socio-economic activities, is shown only in monetary terms (this is the NAM part of the NAMEA). The classification of production activities, as it is applied for the monetary input-output tables, is used also for the breakdown of the environmentally relevant flows in the EA tables of the NAMEA. In practice this approach is quite widely

<sup>15</sup> This chapter draws upon an original text provided by Karl Schoer.

used for linking the different type of residuals (e.g. air emissions) to the generating economic activities.

In terms of the complete NMFacc framework presented in chapter Chapter 3, the EA tables of the NAMEA can be seen as partial and specialised collections of individual rows (for inputs) or columns (for outputs) of the PIOTs. Though the latter can in principle have any desired level of aggregation, from the total aggregate cross-boundary flow to very specific flows of harmful substances, in practice PIOTs would not be feasible and are also not necessary for many analytical purposes.

In the following we will concentrate on the physical vectors for the input flows of natural resources from the environment to production activities and for the products imported for intermediate use. Most of the reasoning however, and the discourse on indirect flows calculation in particular, could easily be adapted to the case of residual flows.

## 2. THE AFTER-EXTRACTION APPROACH TO BREAKDOWN OF INPUTS

For the calculation of physical input vectors the elements of the domestically extracted materials and imported products have to be allocated to the consuming economic production branches and final use activities (use structure). As far as the domestically extracted materials are concerned, there are two options for their treatment. They can be allocated either before or after extraction. In the first option the materials are looked at as environmental resources, i.e. at the point where they enter the domestic socio-economic system and therefore they are assigned to the extracting branches.

In the second variant the extracting branches are not regarded as users, but are classified rather as extracting agents who provide the service of making available the raw materials. So, in the second option the materials are looked at as raw materials, i.e. at the point where they are delivered by extracting branches and therefore they are assigned to the production branches or final use categories which transform or consume the specific materials. For each raw material this information would be present in the corresponding PIOT as the row of the extracting industry. However, it is quite improbable that PIOTs are developed at a high level of detail by material, while this is easier in a NAMEA-approach for selected materials.

Referring to the classification of materials introduced in chapter Chapter 3, in the allocation-before-extraction approach, the object of allocation are natural resources or environmental inputs, while in the allocation-after-extraction approach the allocated materials are products (raw materials). For minerals and non-cultivated biomass extraction, the total quantity of materials included in the input vector, measured as the run-of-mine production, is the same in both cases, as the natural materials discarded in the extraction phase are unused materials not included in the natural resources extracted nor in the raw materials derived thereby. The case is different for cultivated biomass raw materials: these are not present as biomass in the direct inputs from nature in the SNA-coherent approach of chapter Chapter 3, but as ecosystem inputs from which also outputs other than the raw material derive. However, considering biomass raw materials rather than ecosystem inputs is perfectly in line with the needs of most practical applications and this difference in the end can be considered an advantage of the after-extraction approach.

Product imports need to be assigned not only to the using activities but also to the raw material categories. The latter assignment is straightforward when the products embody only one kind of raw material and can be done in various ways for doubtful cases, e.g. according to the main raw material category of which they are made, splitting them between different categories or allocating them to a "compound materials" category.

The allocation of product imports to the activities necessarily is after-extraction (and for semi-finished and finished products, even after-processing). This makes the summing up of the domestically extracted raw materials with the imported ones more meaningful, though still not fully coherent (the semi-finished and finished inputs from domestic production should in principle also be included – but this would require having the whole PIOT!). The first perspective provides useful information as well, and is in some cases a precondition for the second (in that it supplies necessary data for it). But, unlike the figures of the second option, these figures cannot be used for comparing intensities (primary material input / gross value added) of branches. In case of primary branches the output in physical terms is related to the monetary output, but for the rest of the branches this ratio indicates the relationship between a physical input and the monetary output.

An example of the resulting database for the inputs to the national socio-economic system in a sectoral breakdown, based on the adoption of the allocation after extraction approach for domestically extracted materials, is shown schematically in Figure 4.1<sup>16</sup>. Data thus organised can provide already a useful basis for analysis, like calculating use intensities in a breakdown by branches or carrying out decomposition analysis or for studying the environmental effects of international trade.

**Figure 4.1: Direct use of primary materials by economic activities and type of material**

Type of material		Economic activities							
		Homogeneous production branches				Final use categories			
		PB1	PB2	...	PBn	Consumption of private households	Public consumption	Capital formation	Exports
Domestically extracted raw materials	DRM1								
	DRM2								
	...								
	DRMn								
Imported raw materials	IRM1								
	IRM2								
	...								
	IRMn								
Imported semi-finished and finished products assigned to the main type of raw material	IP1								
	IP2								
	...								
	IPn								
Total raw materials and products thereof	DRM1 + IRM1 + IP1								
	DRM2 + IRM2 + IP2								
	...								
	DRMn + IRMn + IPn								

### 3. INDIRECT FLOWS OF PRODUCTS AND RAW MATERIAL EQUIVALENTS

Indirect flows can in principle be considered for products at any stage of elaboration and be referred to the flows of the necessary inputs for producing them at any of the upstream production stages. E.g. the indirect flows of a product going to intermediate consumption in terms of materials crossing the boundary of the national socio-economic system could be defined (i.e. in terms of environmental resources and imported products used). However, the most common and important applications of the

<sup>16</sup> This example is based on the application of the breakdown by the German Federal Statistical Office.

concept of indirect flows concern products going to final use (consumption of households, accumulation and exports) at one end of the chain and material inputs from nature at the other end.

It is an important aim of a breakdown by activity and by type of (raw) material to analyse the chain that goes from causing socio-economic activities (driving forces) over the use and release of material (pressures) to the environmental impacts related to the use of the individual materials. However, so far as the imported products are concerned the original values can give only a rather rough and incomplete picture of the quantity and the composition of natural resources and residuals that are behind those products.

To give an example, the weight of a car does not represent the original weight of the materials (e.g. different metal ores and energy carriers) that were used over the whole production chain for producing the car, as the part transformed into residuals of these materials is not physically embodied in the car, but remained in the countries where the car has been assembled, its pieces produced and the raw materials for the pieces extracted. And if the car is assigned entirely to the main type of raw material, which is iron, all other materials are neglected. These shortcomings can only be overcome by converting the imported products into so called raw material equivalents (RME) which also include the indirect use of materials in the rest of the world. Moreover, the connected unused flows should be also considered if knowledge of all environmentally relevant flows is wanted.

Two components of indirect flows of (imported and exported) products are distinguished:

- a. Up-stream indirect flows of used materials that are part of the Raw Material Equivalents (RME) of the imported or exported products, i.e. the RME less the weight of the imported or exported product. The RME is the used extraction that was needed to provide the products;
- b. Up-stream indirect flows of unused extraction (e.g. mining overburden) associated to this RME.

The distinction between the two components of indirect flows is shown in Figure 4.2, which also illustrates a two-step calculation method that allows keeping them distinct. The first step (1) is to compile the RME of imports or exports, i.e. the vector of raw materials needed to provide the product at the border. In a second step (2) the unused extraction associated to this RME is compiled. The 1a path represents a shortcut that may be taken when the available information does not allow to distinguish the used part of indirect flows from the unused part, which is however not the recommended method.

**Figure 4.2: Indirect flows of used and unused materials**

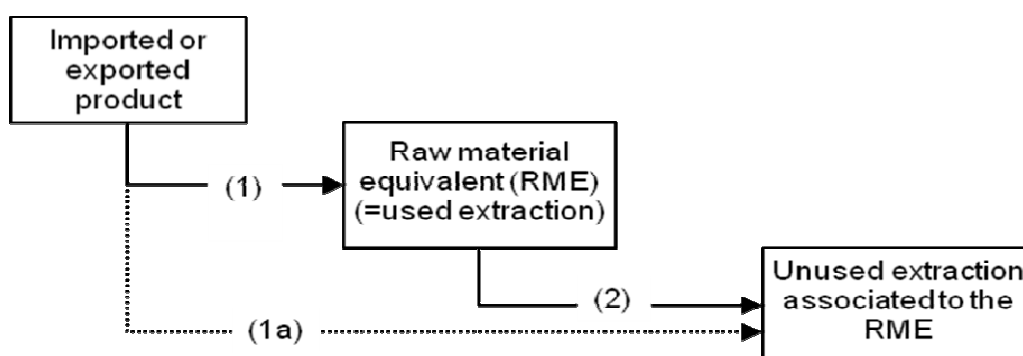

The RME of some traded products such as raw materials and even some semi-manufactures may be assumed to differ only marginally from the mass of the product itself. The difference would for example correspond to some fuel used to extract and transport a raw material to the border. For these

materials indirect flows only comprise unused extraction, so that the RME step can be suppressed in calculation (1a in the figure).

When imports and exports are converted into their RME, the weight of the RME includes the mass of the imports or exports. The indirect flows of type (a) (i.e., those based on the RME) are calculated by subtracting the weight of the imports or exports from the RME associated to these imports or exports so as to ensure additivity.

Some of the indirect flows associated to exports may consist of the indirect flows associated to products previously imported. This effect would be particularly pronounced for countries with important harbours where a substantial part of imports is direct transit to other countries.

#### 4. APPROACHES TO THE CALCULATION OF INDIRECT FLOWS

There are two principal approaches for estimating the indirect input of a material related to the imported products, the IOT-approach and the coefficient approach:

- The IOT-approach in a first step estimates the raw material content of the domestic products by type of material. In a second step that relationship is applied to the imported products. For estimating the raw material content of the different domestic products the physical input vectors (use structure) for the individual raw materials are combined with a domestic IOT-matrix in a Leontiev type approach. That type of IOT-approach is applicable on condition that the domestic production conditions represent the relationships in the exporting economies in sufficient manner. That may be the case for most finished and semi-finished products and some raw materials.
- The coefficient approach has to be used for imported materials that are not produced in the domestic economy at all or which are produced under climatic, geo-physical or other conditions that are considerably different from the domestic relationships. Ideally for those products the analysis should be based also on the IOT matrixes (of the exporting countries). As it is not realistic that this type of comprehensive information could be obtained, the aim has to be achieved by a simpler co-efficient type approach, which utilises information on direct, and as far as possible, on indirect the raw material inputs into the respective foreign production processes.

Indirect flows associated to imports and exports should be calculated using input-output techniques in the same way as e.g. 'embedded' energy is calculated. However, compilation of indirect flows with input-output techniques alone may be limited. Ideally, specific coefficients per product category would be available based on process chain analysis. Data on indirect flows will usually suffer from some degree of imprecision but their calculation can shed light on the effects of trade and globalisation. Such questions may become increasingly important with the further integration among national economies.

The accounts for indirect flows of unused materials should be based, to the extent possible, on direct information on the trading partners. A practical solution may also be – in a stepwise approach – to focus on some important indirect flows of unused materials (e.g. associated to raw materials imported) first and achieve completeness later. Direct information on the trading partners may also be useful for some other flows. For example, for electricity imported the fuels required abroad to generate the electricity would be indirect flows associated to imports.

## 5. COMPARISON OF IOT-APPROACHES

The calculation of raw material equivalents as it is discussed in the following aims at calculating the RME by type of raw material. Figure 4.3 illustrates what elements are needed for arriving at RME by type of raw material. What is obtained in the end is the row "Total raw material equivalents for imports" which sum up the raw material equivalents by type of raw material for all imports.

**Figure 4.3: Raw material equivalents for imported products by type of raw material**

Type of product		Type of raw material				Total raw materials
		RM1	RM2	...	RMn	
Direct imports of raw materials	RM1					
	RM2					
	...					
	RMn					
Indirect imports of raw materials related to the directly imported raw materials	RM1					
	RM2					
	...					
	RMn					
Indirect imports of raw materials related to the direct imports of semi-finished and finished products	PG1					
	PG2					
	...					
	PGn					
Total raw material equivalents for imports		Total				

For the IOT-approach different types of IOT matrixes can be applied. The principal options are shown in Figure 4.4:

**Figure 4.4: Possible IOT-matrixes for calculation of the indirect use of raw material by type of product**

Type of IOT matrix	Type of use	Description
Monetary IOT	Monetary	Standard MIOT is applied for each type of raw material
Physical IOT	Full	Standard PIOT is applied for each type of raw material
	Simplified	Simplified PIOT is applied for each type of raw material
Hybrid IOT	Simple	1. Special IOT-matrix for each type of raw material 2. The use structure for the first step of the production chain (use of raw material after extraction) is replaced by physical information
	Expanded	1. Special IOT-matrix for each type of raw material 2. The use structures for the first steps of the production chain (usually more than one) are replaced by physical information 3. Symmetrical disaggregation of relevant homogenous branches of the standard IOT classification

The principal approaches are based either on a monetary (MIOT), a physical (PIOT) or on a hybrid (HIOT) input-output matrix. For the MIOT-approach the physical raw material input vectors for each type of raw material (use structure) are coherent with the MIOT.

The PIOT-approach applies a physical IOT-matrix with the same standard disaggregation by branches as the MIOT. Compared to that the simplified PIOT approach refrains from disaggregating those branches that are less relevant in terms of material input.

A general feature of the HIOT-approach is that in principle there has to be constructed not only one standard HIOT, but a special HIOT for each type of material. For constructing a HIOT the monetary use structures for the raw material under consideration and related products are replaced by physical information. With regard to the level of branch-disaggregation of the IOT either the standard frame can be used or a symmetrically expanded type of IOT where the relevant production processes for the raw material under consideration, are shown in more detail. Two typical types of HIOT are shown in Figure 4.4, the so-called simple HIOT and the so-called expanded HIOT. The simple HIOT differs from the MIOT only by replacing the first step of the production chain (use of raw material after extraction) by physical information. The expanded HIOT represents a sectoral enhanced IOT matrix. In addition for the expanded HIOT, usually the use structures of more than one step of the production chain are replaced by physical information. Figure 4.5 illustrates what type of information is utilised in the different types of IOT-matrices.

**Figure 4.5: Depiction of the flow of a domestic raw material category through the first stages of the production chain by different types of IOT-matrixes**

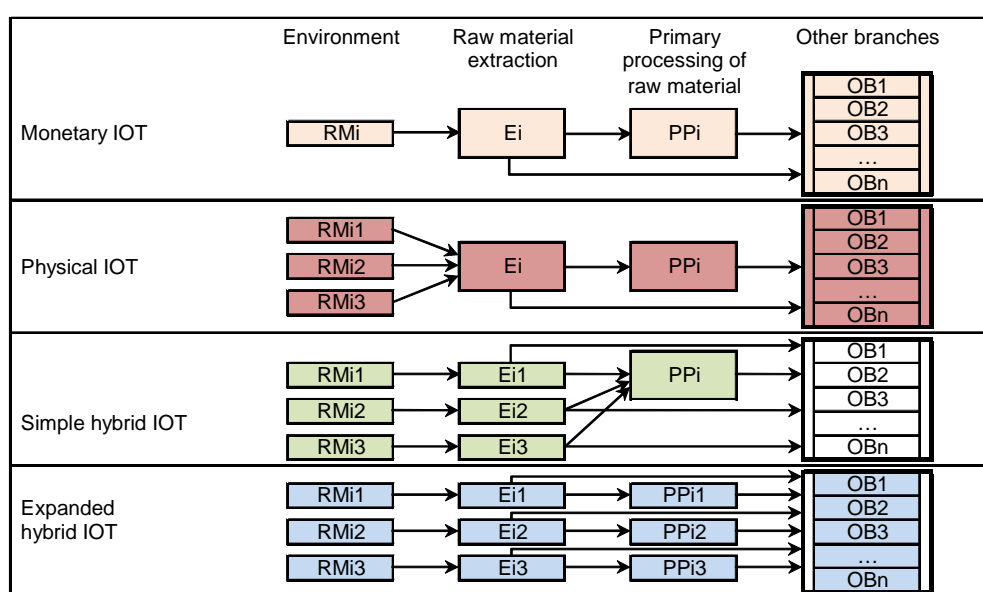

In the example given in the figure the observed raw material category (e.g. metals) consists of three different types of raw material. For each individual raw material a part of the extracted material is used in a special production process for a further processing of that raw material. An other part is directly used by other branches. It is assumed in this example that in the standard IOT there is only one extraction branch for the whole raw material category. The primary processing for that category is also located in one aggregated branch. The example reflects the conditions of the real IOT rather realistically.

Generally it can be stated that miss-assignment in the first steps of the production chain is much more critical for the result than a biased allocation in later stages. The reason is that the materials in the first steps are processed in rather specific processes with special input relations. At later processing stages the original raw material is widely scattered over a large number of branches.

The most widespread approach in practice is using a MIOT for the calculation of indirect effects. The MIOT is easily available as part of the regular programme of the National Accounts with no additional costs. However having in mind the aim of calculating indirect effects for individual raw materials, the MIOT approach will only yield reasonable results for the individual raw materials on condition that the "assumption of homogeneity" (i.e. the aggregated monetary output structures represent the physical use structure of the individual material adequately) is valid, especially with regard to the first steps of

the production chain. It is more likely that this condition holds for raw materials that are already rather widely scattered over the whole economy in the first steps of the production chain, like energy carriers, than for very specific raw materials which are processed in some few special production processes. To give an example: The MIOT relationship are certainly not appropriate for allocating the raw material copper to the final uses, as the use structures for copper ore and semi-finished copper products certainly differ from the structures for all metals together, which are provided by the standard IOT as a proxy .

There will be some improvement by using a PIOT-matrix because, physical output-structures are applied instead of monetary ones. That means that in the aggregates for the total raw material categories at least the effects of different prices per weight unit are eliminated. But the problem still remains that in purely physical terms the aggregated use-structure can be different from the use-structure for the individual material. Only if it were the aim to allocate the total raw material input and not the individual raw materials to the final uses, the PIOT would be clearly superior to the MIOT.

Moreover, it should be considered that indirect flows calculation should include all materials that are needed to produce the imported goods. Now, in PIOTs the flow from activities providing immaterial products to other activities are null. This implies that if PIOTs are used for the analysis of upstream flows, the causation chain will be interrupted there. In reality, however, what counts for indirect flows is not how much a certain industry physically delivers to the other but the materials it uses for producing what it delivers, independently from the degree of materiality of its deliveries. For example, the fossil fuels needed for the production of the electricity necessary for producing an imported car would not be included in the indirect flows of the imported cars calculated with a PIOT (hybrid approaches including physical units other than mass have also been developed in order to avoid this problem). The same is true for service inputs to the production and delivery of the imports that in turn required material inputs (e.g. transport of the components of the car and of the car itself).

The simple HIOT-approach will lead to a considerable improvement compared to the results of the PIOT-approach. In this case a special HIOT is established for each type of raw material with physical information for the first step of the production chain. The approach directly includes information on the physical use of the individual raw material. However, in case of copper for example, the simple HIOT approach may still not yield satisfying results, because in the next step of the chain, the primary processing of copper is put together in one production branch with all other non-ferrous metals.

Whereas compiling a complete PIOT is a rather resource consuming task, as the physical relationships have to be estimated over the complete production chain, the data requirement for the calculation of a simple HIOT is comparatively small. As far as no direct physical information is available the required use structures can be derived with sufficient accuracy from the detailed internal supply and use tables which are used in the National Accounts among others as a basis for compiling the monetary IOT. In practice the calculation of indirect effects with the simple HIOT can be done by just combining the MIOT with the respective physical raw material input vector after extraction (see option 2 under simple hybrid IOT of Figure 4.4), as that vector carry already the information of the physical distribution to the first users.

The expanded IOT approach facilitates further improvement of the results compared to the simple HIOT-approach. As can be seen from example shown in Figure 4.5, in that approach the special physical use-structures of the individual raw materials are applied also for the second and if necessary for even more steps of the production chain, due to more detailed disaggregation of the relevant production processes.

In practice, a mix of simple and expanded HIOT may be applied, depending on the production conditions for the individual raw material under consideration.

*Chapter 5.***ECONOMY-WIDE MATERIAL FLOW ACCOUNTING (EW-MFACC) FRAMEWORK FOR NATIONAL SYSTEMS<sup>17</sup>****1. OBJECTIVES AND MAIN CHARACTERISTICS OF EW-MFACC AND RELATION WITH THE FULL-FLEDGED NATIONAL MFACC SCHEME**

The practical feasibility of the accounting schemes presented in the Chapter 3 is somewhat restricted by data availability, especially when trying to actually measure the internal material flows of the socio-economic system. The economy-wide material flow accounting (EW-MFACC) framework presented in this chapter ignores almost totally these flow. It is characterised by a high level of aggregation by activity (but not necessarily by material), as it focuses on the flows crossing the boundary of the national socio-economic system, and reinforces the emphasis on solid natural resources and raw materials as focus materials also present in the NMFAcc framework.

Also the measurement of some flows from and to the natural environment may be quite difficult. Moreover, if the NMFAcc system boundary is applied at a high level of aggregation of human activities, the conventions deriving from coherence with national accounts may imply that some important piece of information that would be present in a full-fledged NMFAcc be concealed. The resulting accounts might even seem to contradict common sense and not be suited for use in some well-established policy contexts and their value added difficult to understand. As a pragmatic response to the connected difficulties, EW-MFACC gives up some coherence with the national accounts for the sake of the feasibility and more immediate readability and usability (at least for some purposes) of the accounts.

The implementation of the EW-MFACC approach is quite widespread in the research community and implemented at the national level by several national statistical offices in EU countries. As a consequence it is relatively standardised and already provides data and indicators that are internationally comparable, also thanks to the work of an expert's Task Force animated by Eurostat, which issued a guidance manual that is largely at the basis of the present chapter.

The EW-MFACC approach organises information, rather than in SU and IO tables, in a series of simple accounts that highlight different aspects of the overall material flows of the human system. Material flows within the national socio-economic system are not presented in these accounts, with the only exception of the flows to and from accumulation (as in Chapter 3.3; however, the RoW was not present there while it is in EW-MFACC). These accounts therefore capture and measure the material throughput of social metabolism mainly at the entry and exit points of matter in/from the national socio-economic system. For example, inter-industry deliveries of products are not described<sup>18</sup>. The EW-MFACC approach is also characterised by a certain emphasis on flows of unused materials and on indirect flows connected to imports and exports.

<sup>17</sup> Heinz Schandl provided a first draft on the EW-MFACC approach described in this chapter.

<sup>18</sup> Information on flows within the economy may however be instrumental for estimating primary input flows, for example when data on primary extraction are lacking.

As for the cross-boundary flows of used materials, there are some differences between the system boundary adopted in EW-MFAcc and those specified in Chapter 3.2. The consequences of these differences for the results are limited to some biomass flows and are important more in conceptual and qualitative terms than in aggregated quantitative terms, as they concern mostly the composition of the inputs of the human system and more precisely their distribution between unused and used materials and among the latter between natural resources and ecosystem inputs. Differences exist also in terminology and classifications and the present discussion should help relating the concepts used in the two contexts and avoid confusion. It is important to note that the two approaches are fully compatible, i.e. they are not alternative. A comprehensive reconciliation table will be introduced at the end of the chapter in order to show how the EW-MFAcc approach is embedded in the more general NMFAcc framework.

Notwithstanding the high level of aggregation of human activities that characterises EW-MFAcc, this approach provides useful insights into the dimension and composition of material flows of national socio-economic systems<sup>19</sup>.

## **1.1. System boundary**

### ***1.1.1 Treatment of semi-natural systems***

The issue of agricultural production and forestry and that of solid waste have been discussed under the “borderline problems” heading (Chapter 3.2.1). Indeed, agricultural land and what grows on it, cultivated forests and landfills have in common the characteristic of not being totally under control of man. Weather conditions still play a major role in agricultural production, and the decomposition of waste in a landfill is beyond the reach of those who manage the site; landfills, moreover, are natural habitats for some wild animal species. The flows from and to these “semi-natural systems” can neither be considered fully natural nor fully under the control of man.

In the NMFAcc scheme presented in Chapter 3, the convention has been established – based on coherence with the monetary national accounts – that a tree cut in a cultivated forest (differently from that cut in a non-cultivated forest) is not a natural resource taken from the environment but an internal flow of the economic subsystem. This convention, while on the one hand allowing to include in the accounts the environmentally relevant information about carbon sequestration by cultivated plants, may on the other hand not be relevant for a user interested in the “extraction” of timber as such, e.g. for the derivation of indicators on forestry activities. In principle, the accounts presented in Chapter 3 can be implemented with a level of disaggregation by activity such that the flow of timber from cultivated forests is visible as a product flow (i.e. by dealing with the forest as with a production activity of its own). However this is time-consuming and requires a great deal of estimation, which must be based on a knowledge of biological processes that may not be under the command of a statistical office, while the harvested quantities of agricultural and forestry products are readily available as standard and long-standing statistical production.

The pragmatic solution offered by EW-MFAcc is therefore that the system boundary of the socio-economic system be shifted in a way that the timber flow appears among the inputs of natural resources. A similar change may concern all cultivated plants, which are reported as harvested quantities – rather than as ecosystem inputs and nutrients – in current statistics. Indeed, cultivated plants are not dealt as with materials belonging to the socio-economic system in the EW-MFAcc approach but as a kind of reservoir from which materials are drawn like in other extraction processes. In the language introduced in Chapter 4, this is an “after extraction” way of looking at cultivated biomass inputs to national human activities.

---

<sup>19</sup> Further details can be found in volume I and volume III.

**Figure 5.1: Treatment of semi-natural systems in EW-MFAcc with respect to the complete and exhaustive NMFAcc framework**

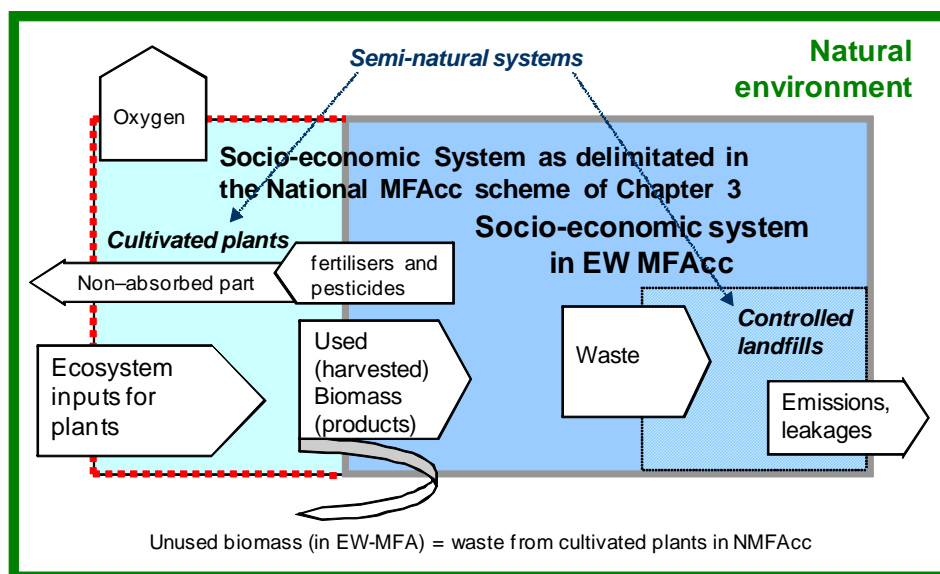

Figure 5.1 graphically shows the difference between the system boundary adopted for the socio-economic system as a whole in EW-MFAcc (continuous line) and that adopted in the complete and exhaustive NMFAcc framework of chapter Chapter 3 (dotted line). As far as cultivated plants are concerned, it can be seen how the boundary on the input side is shifted inwards in EW-MFA and which flows are involved in the change, appearing. Indeed, the national MFAcc scheme presented in the previous chapter, by covering a larger system, embeds EW-MFAcc.

The flow of waste to controlled landfills is in principle considered as an internal flow of the socio-economic system in EW-MFAcc, exactly as in the accounts of chapter Chapter 3<sup>20</sup>. However, it is an express requirement that – notwithstanding the high aggregation level of activities, landfilling of waste be distinguished from other forms of accumulation, as its very different nature is acknowledged. Moreover it can be noted that in many current applications the distinction between controlled and uncontrolled landfilling is not implemented and in most if these cases all landfilled waste is dealt with as an output to nature (and consequently the emissions from landfills are not counted as such, but as internal flows of nature). Figure 5.1 also shows the flows connected to controlled landfills (represented as a box in the lower right corner of the socio-economic system area).

If the disaggregation of economic activities is such that the flows from and to cultivated plants and from and to landfills are visible, the full-fledged NMFAcc scheme of section Chapter 3.6 provides all the data necessary for constructing the EW-MFAcc described here.

### 1.1.2 Residence versus territory principle

EW-MFAcc system boundary for the national socio-economic system diverge from those of the SNA-coherent NMFAcc framework – and consequently also from monetary national accounting ones – in that there is a tendency in NMFAcc to apply the territory (rather than the residence) principle. This is mainly because the application of the residence principle is not an easy task since the basic physical statistics are mainly established for the national territory (see e.g. land use, agricultural and forestry statistics, mining and quarrying statistics). Therefore, the focus of EW-MFA lies in the material flows from and to a country's territory, rather than on those from and to the national socio-economic system.

<sup>20</sup> This follows the latest recommendation on the issue of the Eurostat Task Force on Material Flow Accounting.

Current experience suggests that the most important difference between applying the residence or the territory principle results from fuel use and corresponding air emissions related to international transport including bunkering of fuels and emissions by ships and international air transport as well as from individual mobility of tourists. These differences mainly concern the transport sector and household's final consumption activities. Obviously, the significance of international transport and tourism activities and in particular the net balance of fossil fuel use and related emissions by resident units abroad and non-resident units on a nation's territory will differ across countries. This has to be taken into careful consideration if indicators have to be derived from the accounts to be used for international comparison: EW-MFAcc usually refer to the national territory. If a measure consistent with monetary national accounts is desired, fuel use and emissions by non-residents on a nation's territory and by residents abroad may be calculated for subtraction from and addition to the EW-MFAcc values respectively.

## 1.2. Identification, denomination and classification of materials

As a consequence of the different system boundary shown above, not all the flows crossing the nature/socio-economic system of the national MFAcc of Chapter 3 are of interest for EW-MFAcc. On the input side, the latter focuses on the "material inputs" to the socio-economic system identified as all the "natural resources" of Chapter 3 plus the harvested portions of cultivated plants ("biomass extraction"). "Work-in-progress" of cultivated plants is not considered part of the socio-economic system.

"Ecosystem inputs" do not exist as such in EW-MFAcc. The item "oxygen for combustion and respiration" is still present and coincides with that of Chapter 3; however, this is called an "input balancing item". The other ecosystem inputs, though used by cultivated plants, are not relevant as such for EW-MFAcc, since these flows are seen as internal to nature, as shown above. However, part of these materials are still present (though not visible as ecosystem inputs) in the accounts, since they are incorporated into the harvested quantities of cultivated plants included in the "biomass extraction".

On the output side EW-MFAcc does not comprise the oxygen produced by cultivated plants, (a residual stemming from agricultural and forestry activity in SNA-coherent NMFAcc). Moreover, as EW-MFAcc focus on the material outputs of the socio-economic system that are potentially harmful to nature, it attributes the qualification of "output balancing items" to the other similar "residuals" that have to be accounted for in order to complete this side of the balance, namely to flows such as water vapour from respiration and combustion.

Flows such as those of fertilisers and pesticides are considered outputs to nature altogether, and denominated "dissipative uses of products". These include both the part absorbed by the cultivated plants (which is dealt with as an internal flow of agriculture in Chapter 3) and the part which is lost in the natural environment (a residual in both frameworks).

As in the more general NMFAcc framework, water and air that become part of a material good during the production process are included in the mass balance. In EW-MFAcc these amounts of water and air are referred to as additional inputs and are accounted for as input balancing items.

## 1.3. Consequences of different system boundary on the quantification of the flows

As a consequence of the differences described above, lower used inputs from the natural environment are recorded in EW-MFAcc. Moreover, the inputs accounted for are differently distributed between "material inputs" and "balancing items" than between "natural resources" and "ecosystem inputs".

Indeed, the flow of ecosystem inputs to the cultivated plants, to be recorded as used inputs under Chapter 3's approach, can be divided in four parts: the one transformed in oxygen by the plants; the one embodied in plants as "work-in-progress"; the one embodied in the parts of the plants

subsequently discarded in the harvesting phase; and the part embodied in the harvested plants themselves. In EW-MFAcc the first two parts do not appear at all and the third one is considered an unused flow, which is not present as such in Chapter 3's accounts (where it is considered waste); only the latter part is included as used biomass in EW-MFAcc.

For the same reasons, unused materials from biomass gathering are much larger in EW-MFAcc, and biomass waste from plants much lower, since the latter is accounted for as an unused flow in EW-MFAcc. Gross accumulation of stocks is also lower in EW-MFAcc, as "work-in-progress" plants are not included (they are dealt with as pure nature).

As far as the outputs to nature are concerned, 100% of fertilisers and pesticides spread on the land are accounted for as outputs to nature in EW-MFAcc. This is in practice not a big difference from SNA-coherent NMAcc since the absorbed part is usually a minor one.

The application of the territory principle rather than of the residence principle implies a different (simpler) treatment of statistical sources in EW-MFAcc, as no corrections are necessary neither to import/export data (for direct purchases of residents abroad and of non residents in the focus country) nor of the usually available estimates of residuals for the corresponding emissions and wastes.

#### **1.4. Supply and use tables at the EW-MFAcc level of aggregation by activity**

As already hinted, EW-MFAcc can be considered a pragmatic version of a very aggregated NMAcc scheme such as that presented in Chapter 3.3. In particular, if we modify those PSUTs to:

- make them realistic by representing material exchanges with the rest of the world and therefore introduce the RoW columns;
- show landfills as a separate entity from useful socio-economic material stocks;
- adjust the measure of some flows according to the new system boundary and the terminology to that currently in use in the EW-MFAcc field

we obtain the example PSUTs of Table 5.1 and Table 5.2.

From the supply table it can be noted that the measure of the material balance of the whole national socio-economic system is quite different from that reported in Table 3.18, even if the underlying figures of our example are exactly the same. Indeed it is not the situation represented that has changed, but the system boundary for the national socio-economic system, from the fully SNA-coherent boundary of Chapter 3 to the EW-MFAcc more pragmatic boundary. It can be assumed that this is not due to the switch from the residence to the territory principle, as the corrections to the inputs and to the outputs connected to that are likely to perfectly compensate each other (i.e. neither residents operating abroad accumulate materials nor do it non-residents operating on the national territory – if it was so, the units would be resident on the territory where they operate). Therefore, the reasons for the change are all in the different system boundary between the socio-economic system as a whole and nature. Indeed, we are excluding from the stocks all biomass growth (for instance managed forests), which in our example grow more than they are harvested.

**Table 5.1: Use table corresponding to the EW-MFAcc of a national socio-economic system (with flows of products of stocks as net flows)**

Use		Socio-economic system						Natural environment	TOTAL USE BY MATERIAL
		National socio-economic system				Rest of the world socio-economic system	Total socio-economic system		
		Material transformation	Useful material stocks	Controlled landfills & other waste storage	Total national socio-economic system				
		T	S	L	H1=T+S+L	H2	H=H1+H2		
Natural resources	N1 - Fossil fuels	65.000	-	-	65.000	-	65.000	-	65.000
	N2 - Ferrous metal ores	5.000	-	-	5.000	-	5.000	-	5.000
	N3 - Non-ferrous metal ores	25.000	-	-	25.000	-	25.000	-	25.000
	N4 - Industrial minerals	15.000	-	-	15.000	-	15.000	-	15.000
	N5 - Construction minerals	140.000	-	-	140.000	-	140.000	-	140.000
	N6, EW-MFA variant - Cultivated and Non Cultivated biomass	62.500	-	-	62.500	-	62.500	-	62.500
	<b>N, EW-MFA variant - All material inputs</b>	<b>312.500</b>	<b>-</b>	<b>-</b>	<b>312.500</b>	<b>-</b>	<b>312.500</b>	<b>-</b>	<b>312.500</b>
Input balancing items	BI1 - Water as a balancing item (EW-MFA variant of N7)	15.000	-	-	15.000	-	15.000	-	15.000
	BI2 - Oxygen for combustion and respiration (=E2 but for non-compliance with the residence principle)	325.000	-	-	325.000	-	325.000	-	325.000
	<b>BI - All input-side balancing items (EW-MFA variant of E)</b>	<b>340.000</b>	<b>-</b>	<b>-</b>	<b>340.000</b>	<b>-</b>	<b>340.000</b>	<b>-</b>	<b>340.000</b>
Products	P1 - Animal and vegetable products	8.500	3.000	-	11.500	3.000	14.500	-	14.500
	P2 - Stone, gravel and building materials	12.000	139.000	-	151.000	12.000	163.000	-	163.000
	P3 - Energy commodities	47.000	1.000	-	48.000	36.000	84.000	-	84.000
	P4 - Metals, machinery, etc.	7.900	7.900	-	15.800	7.000	22.800	-	22.800
	P5 - Plastic and plastic products	3.000	2.500	-	5.500	2.000	7.500	-	7.500
	P6 - Wood, paper, etc.	1.500	3.000	-	4.500	4.000	8.500	-	8.500
	P7 - Water, chemicals and other commodities	8.000	4.000	-	12.000	5.500	17.500	-	17.500
	<b>P - All products</b>	<b>87.900</b>	<b>160.400</b>	<b>-</b>	<b>248.300</b>	<b>69.500</b>	<b>317.800</b>	<b>-</b>	<b>317.800</b>
Residuals	W1 - GHGs, acidifying substances, ozone layer depleters	-	-	-	-	-	-	283.000	283.000
	W2 - Heavy metals to air	-	-	-	-	-	-	0.020	0.020
	W3 - Other toxic substances to air (POPs, PCBs, etc.)	-	-	-	-	-	-	0.030	0.030
	W5 - Nutrients to water	-	-	-	-	-	-	0.940	0.940
	W6 - Heavy metals to water	-	-	-	-	-	-	0.010	0.010
	W7 - Other water-polluting residuals (oil spills, solid waste etc.)	0.200	-	-	0.200	-	0.200	1.000	1.200
	W8 - Hazardous waste	1.000	-	10.500	11.500	0.200	11.700	0.500	12.200
	W9 - Construction and demolition waste	11.300	-	13.000	24.300	-	24.300	1.500	25.800
	W10 - Other non-hazardous waste	3.500	-	16.000	19.500	1.500	21.000	18.000	39.000
	W11, EW-MFA variant - Manure, fertilisers, sewage, residual water	-	-	-	-	-	-	18.500	18.500
		<b>W, EW-MFA variant - All end-of-life-cycle outputs (excluding output balancing items BO)</b>	<b>16.000</b>	<b>-</b>	<b>39.500</b>	<b>55.500</b>	<b>1.700</b>	<b>57.200</b>	<b>323.500</b>
	<b>BO - Output balancing items: other gaseous residuals (vapour, etc.) (= W4 minus oxygen produced by cultivated plants)</b>	<b>-</b>	<b>-</b>	<b>-</b>	<b>-</b>	<b>-</b>	<b>174.000</b>	<b>174.000</b>	
	<b>TOTAL MATERIAL USE BY ACTIVITY (All materials = N+BI+P+W, EW-MFA variant+BO)</b>	<b>756.400</b>	<b>160.400</b>	<b>39.500</b>	<b>956.300</b>	<b>71.200</b>	<b>1,027.500</b>	<b>497.500</b>	<b>1,525.000</b>
Unused Materials	U1, EW-MFA variant - Plants and animals	3.000	-	-	3.000	-	3.000	3.000	
	U2 - Mining overburden	55.000	-	-	55.000	-	55.000	55.000	
	U3 - Soil removal	40.000	-	-	40.000	-	40.000	40.000	
		<b>U, EW-MFA variant - All unused</b>	<b>98.000</b>	<b>-</b>	<b>-</b>	<b>98.000</b>	<b>-</b>	<b>98.000</b>	<b>98.000</b>

**Table 5.2: Supply table corresponding to the EW-MFAcc of a national socio-economic system**

Supply		Socio-economic system						Natural environment	TOTAL SUPPLY BY MATERIAL
		National socio-economic system				Rest of the world socio-economic system	Total socio-economic system		
		Material transformation	Useful material stocks	Controlled landfills & other waste storage	Total national socio-economic system				
		T	S	L	H1=T+S+L	H2	H=H1+H2		
Natural resources	N1 - Fossil fuels	-	-	-	-	-	-	65.000	65.000
	N2 - Ferrous metal ores	-	-	-	-	-	-	5.000	5.000
	N3 - Non-ferrous metal ores	-	-	-	-	-	-	25.000	25.000
	N4 - Industrial minerals	-	-	-	-	-	-	15.000	15.000
	N5 - Construction minerals	-	-	-	-	-	-	140.000	140.000
	N6, EW-MFA variant - Cultivated and Non Cultivated biomass	-	-	-	-	-	-	62.500	62.500
<b>N, EW-MFA variant - All material inputs</b>		-	-	-	-	-	-	<b>312.500</b>	<b>312.500</b>
Input balancing items	BI1 - Water as a balancing item (EW-MFA variant of N7)	-	-	-	-	-	-	15.000	15.000
	BI2 - Oxygen for combustion and respiration (=E2 but for non-compliance with the residence principle)	-	-	-	-	-	-	325.000	325.000
	<b>BI - All input-side balancing items (EW-MFA variant of E)</b>	-	-	-	-	-	-	<b>340.000</b>	<b>340.000</b>
Products	P1 - Animal and vegetable products	6.000	-	-	6.000	8.500	14.500	-	14.500
	P2 - Stone, gravel and building materials	151.000	-	-	151.000	12.000	163.000	-	163.000
	P3 - Energy commodities	34.000	-	-	34.000	50.000	84.000	-	84.000
	P4 - Metals, machinery, etc.	12.900	-	-	12.900	9.900	22.800	-	22.800
	P5 - Plastic and plastic products	4.000	-	-	4.000	3.500	7.500	-	7.500
	P6 - Wood, paper, etc.	7.000	-	-	7.000	1.500	8.500	-	8.500
	P7 - Water, chemicals and other commodities	9.500	-	-	9.500	8.000	17.500	-	17.500
<b>P - All products</b>		<b>224.400</b>	-	-	<b>224.400</b>	<b>93.400</b>	<b>317.800</b>	-	<b>317.800</b>
Residuals	W1 - GHGs, acidifying substances, ozone layer depleters	282.000	-	1.000	283.000	-	283.000	-	283.000
	W2 - Heavy metals to air	0.020	-	-	0.020	-	0.020	-	0.020
	W3 - Other toxic substances to air (POPs, PCBs, etc.)	0.030	-	-	0.030	-	0.030	-	0.030
	W5 - Nutrients to water	0.940	-	-	0.940	-	0.940	-	0.940
	W6 - Heavy metals to water	0.010	-	-	0.010	-	0.010	-	0.010
	W7 - Other water-polluting residuals (oil spills, solid waste etc.)	1.000	-	0.100	1.100	-	1.100	0.100	1.200
	W8 - Hazardous waste	11.200	0.700	-	11.900	0.300	12.200	-	12.200
	W9 - Construction and demolition waste	13.000	12.800	-	25.800	-	25.800	-	25.800
	W10 - Other non-hazardous waste	35.300	3.700	-	39.000	-	39.000	-	39.000
	W11, EW-MFA variant - Manure, fertilisers, sewage, residual water	18.500	-	-	18.500	-	18.500	-	18.500
	<b>W, EW-MFA variant - All end-of-life-cycle outputs (excluding output balancing items BO)</b>	<b>362.000</b>	<b>17.200</b>	<b>1.100</b>	<b>380.300</b>	<b>0.300</b>	<b>380.600</b>	<b>0.100</b>	<b>380.700</b>
<b>BO - Output balancing items: other gaseous residuals (vapour, etc.) (= W4 minus oxygen produced by cultivated plants)</b>		<b>170.000</b>	<b>1.000</b>	<b>3.000</b>	<b>174.000</b>	-	<b>174.000</b>	-	<b>174.000</b>
<b>TOTAL MATERIAL SUPPLY BY ACTIVITY (All materials = N+BI+P+W, EW-MFA variant+BO)</b>		<b>756.400</b>	<b>18.200</b>	<b>4.100</b>	<b>778.700</b>	<b>93.700</b>	<b>872.400</b>	<b>652.600</b>	<b>1,525.000</b>
<i>Balance (material accumulation by activity)</i>		-	142.200	35.400	177.600	-22.500	155.100	-155.100	-
Unused Materials	U1, EW-MFA variant - Plants and animals	3.000	-	-	3.000	-	3.000	3.000	
	U2 - Mining overburden	55.000	-	-	55.000	-	55.000	55.000	
	U3 - Soil removal	40.000	-	-	40.000	-	40.000	40.000	
	<b>U, EW-MFA variant - All unused</b>	<b>98.000</b>	-	-	<b>98.000</b>	-	<b>98.000</b>	<b>98.000</b>	

## 2. MAIN AGGREGATES OF EW-MFACC

### 2.1. Direct material inputs

Direct (used) material inputs are defined as all solid, liquid and gaseous materials (excluding water and air but including e.g. the water content of materials) that enter the socio-economic system, as delimited above, for further use in production or consumption processes. The two main categories are Domestic Extraction (DE) of natural resources and Imports. A further classification of DE by material kind sees biomass, fossil fuels and minerals as main sub-categories.

### 2.2. Unused domestic extraction

Unused domestic extraction differs in EW-MFACC from what seen in Chapter 3.2 only for what concerns the unused biomass flows, as discussed in subsection 1.3 of the present chapter. It includes materials extracted or otherwise moved on a nation's territory on purpose and by means of technology which are not fit or intended for use. Examples are soil and rock excavated during construction, dredged sediments from harbours, and overburden from mining and quarrying and unused biomass from harvest. Agricultural soil that is eroded is not moved on purpose but may be included as an optional memorandum item.

Unused domestic extraction is of the same order of magnitude as direct (used) material input in industrialised countries. These unused material flows are counted as both inputs and outputs, with the net effect for the material balance being zero.

### 2.3. Outputs to the environment

Outputs to the environment are defined as all material flows entering the national environment, either during or after production or consumption processes. Outputs include emissions to air and water, waste landfilled as well as dissipative use of materials (such as e.g., fertiliser or thawing materials). Outputs also include the disposal of unused domestic extraction.

### 2.4. Memorandum items for balancing

EW-MFACC are usually drawn in actual (reported) weights. With this convention most of the accounts can be set up based on existing data. However, for the full material balance, material inputs and outputs must be measured consistently. As a consequence some of the ecosystem inputs and of the residuals considered in Chapter 3, though not belonging to the focus materials of EW-MFACC, also have to be considered. For example, in combustion processes, the fuels are combined with air and oxidised, resulting in emissions to air including carbon dioxide and water vapour as well as other residues such as ashes. The difference in weight between fuel inputs and emission can be quite large. For example, only 27% of the total weight of CO<sub>2</sub> emissions is carbon while 73% is oxygen. Another example is the water content of inputs of biomass or minerals or of outputs of waste - the weights as recorded by statistical sources often includes the water content of these inputs and outputs.

There are different options to ensure consistency of the material balance and to allow a meaningful interpretation of differences between inputs and outputs. It is here recommended to introduce memorandum items for balancing. These memorandum items are only introduced for balancing purposes. They are not to be included in the indicators derived from the accounts. Important memorandum items for balancing are listed in the classifications of inputs and outputs.

For example, for the air emissions to balance with the fuels used in combustion, the oxygen must be included as a memorandum item for balancing on the input side. Alternatively, CO<sub>2</sub> emissions and water vapour could be described only in terms of their carbon and hydrogen content. Also memorandum items for the water content of materials will have to be introduced.

The memorandum items for balancing are quantitatively important. The balancing items include the oxygen for combustion, for bio-metabolism and for the production of technical gases as well as the water input for evaporation by animal and human metabolism on the input side. On the output side, the balancing items include the water vapour from combustion (from the water content of fuels and from oxidation of hydrogen in fuels) as well as the water evaporation from animal and human metabolism.

## 2.5. Indirect flows of used and unused materials

In economy-wide MFA only flows that cross the system boundary of the economy are recorded. The term 'indirect flows' therefore only refers to upstream flows associated to imports and exports of this economy.

On the input side, indirect flows are defined as the up-stream material flows that are associated to imports but are not physically imported. On the output side, indirect flows are defined as the upstream material input flows associated to exports but are not physically exported. Indirect flows are the 'cradle to border' inputs necessary to make a product (i.e., a good or a service) available at the border for import or export, excluding the mass of the product itself. Two types of indirect flows associated to imports and exports are distinguished: used and unused indirect flows. Indirect flows can only be calculated after the accounts for direct (used) materials have been completed. For a more detailed description including a discussion of IOT-based calculation methods see Chapter 4.

Compiling the unused extraction associated to imported raw materials and some semi-manufactures may be a useful first step in the analysis, allowing a first estimate of indicators including indirect flows. In this case it is recommended to document the categories that have been included in compiling these indicators. With the increasing importance of finished goods and of services in imports (and exports) the error introduced by this simplification may become quite large. The structure of imports and exports by broad categories (raw materials, semi-manufactures, finished products) and its change over time provides a useful indication for the size and development of this error.

The RME of imports allows compiling input indicators based entirely on RME by substituting the imported products by their RME. Compiling also RME for exports permits calculating indicators of apparent material consumption expressed in RME.

Complementary analyses may be made, e.g. calculation of emissions or units of land use equivalent associated to products imported or exported. For example, in addition to the indirect material flows, the land used abroad to produce the goods and services imported by a nation as well as the land used nationally to produce the goods and services exported may be estimated. Indicators may be derived for land use 'imported and exported' as well as a net trade balance expressed in hectares. Similarly, emissions 'imported or exported' (and the balance of these) may be calculated, i.e. the emissions to air or water or the waste generated abroad to produce the goods and services imported by a nation as well as the emissions and wastes generated domestically to produce the goods and services exported. These aspects are not further explored here.

### 3. CLASSIFICATIONS

The classifications presented are based on the following principles:

- The classifications should allow distinguishing between renewables and non-renewables, i.e. allowing separate identification of biomass;
- The main level of the classification of domestic extraction carries through to all other classifications to allow compilation of sub-accounts and derivation of indicators by main material groups (e.g., separately for fossil fuels, minerals and biomass).

If controlled landfills (or forests and agricultural plants) are treated as part of the economy, some adjustments to the classifications will be needed. For example, in the classification of outputs the waste land filled has to be replaced by the emissions and leakages from landfills. In the classification of changes in stocks, waste land filled has to be added to the additions to stocks and emissions and leakages from landfills to the removals.

#### 3.1. Material inputs from nature and the rest of the world

##### 3.1.1 Direct material inputs

Direct material flows are first classified by their origin into domestic extraction (used) and imports. Material inputs of domestic origin are further classified into three main material groups:

- fossil fuels (coal, oil, natural gas, other);
- minerals (metal ores, other industrial minerals, construction minerals);
- biomass (food, fodder, timber, other).

*Imports* should be classified according to their level of manufacturing into raw materials, semi-manufactured products, finished products and other products. Other products are products without further characterisation of their manufacturing level in the classifications of foreign trade, mostly products of the nutrition industry. Imports (and exports) are classified according to the Harmonised commodity description and coding System (HS) and the Standard International Trade Classification (SITC - derived from HS).

The classification of imports (which is also used for exports) with its sub-categories for raw materials, semi-manufactures and finished products as proposed here is potentially laborious as it requires to aggregate trade data from detailed levels but has the advantage of showing trends in the structure of foreign trade.

A further classification level for imports (and exports) is based, as for domestic extraction, on the kind of material:

- from fossil fuels
- from minerals
- from biomass.

This material attribution is clear for base materials like coke (semi-manufactured fossil fuels), pig iron (semi-manufactured metals) or copper ware (finished metal products). These three basic categories can be further specified like the corresponding domestic extraction categories.

However, since imports and exports are products which may be highly composite, there may be need for some other category ("mixed materials") at this level or for percentage allocation of some commodities. The more complex the materials mix of a manufactured product, the more critical its

attribution to a 'dominant' material category. The share of 'secondary' material categories (e.g., synthetic materials in cars) may be important and may change over time so that it may be necessary to set up conversion tables for the detailed attribution of imports (and exports) to material categories.

### **3.1.2 Unused domestic extraction**

*Unused domestic extraction* comprises three major groups:

- Unused extraction from mining and quarrying (mining/quarrying extraction wastes such as overburden, interburden and parting materials);
- Unused extraction from biomass harvest (discarded by-catch, wood harvesting losses – i.e. timber felled but left in the forests, other harvesting wastes);
- Soil (and rock) excavation and dredged materials (materials extracted during construction and dredging activities).

### **3.1.3 Memorandum items for balancing: air inputs**

Although air is not treated as a material input for the derivation of indicators, it is useful to estimate the oxygen demand of some processes to ensure that inputs and outputs balance. Hence, oxygen will appear as a memorandum item on the input side corresponding to the emissions on the output side of oxidised compounds (CO<sub>2</sub>, water vapour, etc.) from combustion and other processes. Input of oxygen (and nitrogen) can be easily estimated based on chemical equilibrium formulae. The input may then be classified as follows:

- Oxygen (O<sub>2</sub>) for the combustion of fuels (i.e. carbon, hydrogen, sulphur, nitrogen, etc. contained in fuels);
- Oxygen (O<sub>2</sub>) for respiration of humans and livestock;
- Nitrogen to balance the NO<sub>x</sub> emissions from combustion;
- Air for other industrial processes.

A classification of material inputs is presented in Table 5.3.

## **3.2. Material outputs to nature, landfills and rest of the world**

The material outputs of the socio-economic system can be classified at the first level by main destination, i.e. into outputs to the environment and exports.

### **3.2.1 Outputs to the environment**

*Outputs to the environment* are defined as all material flows entering the environment, either during or after production or consumption processes. Included is the disposal of unused domestic extraction. Outputs to the environment can be classified further into processed and unprocessed outputs. *Unprocessed outputs* correspond to the disposal of unused domestic extraction (equal to unused domestic extraction on the input side). *Processed outputs* are the result of production or consumption processes. Processed outputs to the environment are classified into:

- Emissions and waste flows;
- Dissipative use of products and dissipative losses of materials.

Main groups of *emissions and wastes* are:

- Emissions to air;
- Waste land filled;
- Emissions to water.

*Dissipative uses of products and dissipative losses* are defined as the quantity (weight) of materials which are dispersed into the environment as a deliberate, or unavoidable (with current technology) consequence of product use. These flows comprise two components: *dissipative uses* (for example, fertilisers and manure spread on fields, or salt and other thawing materials spread on roads), and *dissipative losses* (for example, rubber worn away from car tires, particles worn from friction products such as brakes, abrasion from roads, losses due to evaporation of e.g. water or other solvents<sup>21</sup> carrying paints or other coatings). Dissipative uses can be part of an ultimate throughput flow, e.g. mineral fertiliser, or part of recycling, e.g. manure, compost and sewage applied on fields for nutrient recycling. *Dissipative uses of products and dissipative losses* are mainly:

- Use on agricultural land (fertiliser, manure etc.);
- Use on roads (sand, salt etc.);
- Losses (corrosion and abrasion of products and infrastructures, leakage etc.).

### **3.2.2 Exports**

*Exports* are classified in the same way as imports. This allows to account for physical trade balances (imports minus exports) and for domestic material consumption (domestic extraction plus imports minus exports) per category of materials. Also *indirect flows associated to exports* may be classified in the same way as those associated to imports.

A classification of material outputs is presented in Table 5.4. This does not include disposal of unused materials and indirect flows, as these are classified in the same way as the corresponding inputs.

### **3.3. Useful material stocks and stock changes**

Useful stocks in the context of EW-MFAcc are mainly man-made fixed assets. They are classified by main categories into Infrastructures and buildings and other stocks (machinery, vehicles, durable goods, etc.). Experience suggests that infrastructures and buildings usually represent more than 90% of the total physical stock and stock changes measured in tonnes. Though being inside the boundary of the socio-economic system, stocks and changes in stocks related to human bodies and livestock, cultivated forests and controlled landfills are not further discussed here.

Stock changes result from the material flows to and from the stocks (additions and removals) during the accounting period. Additions to the stock of infrastructures and buildings would be construction materials for new constructions or renewal, and removals would be construction and demolition wastes (and dissipative losses by corrosion and abrasion of infrastructures and buildings). In the case of machinery, vehicles and similar durable goods, additions would be new machines or new parts, removals would be the wastes from discarding these durable goods. Demolition waste recycled and used for new constructions should be included under both gross additions and removals, leaving the net additions unaffected. Removals could also be due to e.g. the export of second-hand durable goods or abandonment of buildings but these flows may not be significant in practice.

---

<sup>21</sup> Solvents may be included in estimates of air emissions (VOCs). Solvents are classified as a dissipative use rather than air emissions. However, in practice data availability may require to adapt the classification and include certain dissipative material flows in emissions and wastes (e.g. to include solvents in air emissions).

**Table 5.3: Classification of material inputs**

<b>Domestic Extraction (Used)</b>	<b>Imports<sup>22</sup></b>
<b>Biomass</b> (including biomass extracted for own final use)	<b>Raw materials</b>
Biomass from agriculture	Biomass
Biomass from agriculture reported by harvest statistics	Fossil fuels
Cereals	Metal ores
Roots and tubers	Minerals
Pulses	Secondary raw materials
Oilcrops	<b>Semi-manufactured products</b>
Vegetables	From biomass
Fruits	From fossil fuels
Treenuts	From metal ores
Fibre crops	From minerals
Other crops	<b>Finished products</b>
Biomass from agriculture as a by-product of harvest	
Crop residues used as fodder	Predominantly from biomass
Straw used for economic purposes	Predominately from fossil fuels
Biomass from grazing of agricultural animals	Predominately from metal ores
Grazing on permanent pastures not harvested	Predominately from minerals
Grazing on other land (including alpine pastures)	
Biomass from forestry	<b>Other products</b>
Wood	Other products of abiotic kind
Coniferous	Other products of biotic kind
Non-coniferous	Other products, n.e.c.
Raw materials other than wood	<b>Packaging material imported with products</b>
Biomass from fishing	<b>Waste imported for final treatment and disposal</b>
Marine fish catch	
Inland waters (freshwater) fish catch	<b>Memorandum items for balancing<sup>23</sup></b>
Other (aquatic mammals and other)	<b>Oxygen for combustion</b> (of C, H, S, N, etc.)
Biomass from hunting	<b>Oxygen for respiration</b>
Biomass from other activities (honey, gathering of mushrooms, berries, herbs etc.)	<b>Nitrogen for emissions from combustion</b>
<b>Fossil fuels</b>	<b>Air for other industrial processes</b>
Hard coal	(liquefied technical gases, polymerisation, etc.)
Lignite (brown coal)	<b>Unused Domestic Extraction</b>
Crude oil	<b>Unused extraction from mining &amp; quarrying of fossil fuels</b>
Natural gas	<b>Unused extraction from mining &amp; quarrying of minerals</b>
Other (crude oil gas, peat for combustion, oil shale, etc.)	<b>Unused biomass from harvest</b>
<b>Metal ores</b>	Wood harvesting losses
Uranium and thorium ores	Agricultural harvesting losses
Iron ores	Other (discarded by-catch, etc.)
Copper ores	<b>Soil excavation and dredging</b>
Nickel ores	Excavation for construction activities
Aluminium ores	Dredging materials
Lead, zinc and tin ores	<b>Indirect flows associated to imports</b>
Other non-ferrous metal ores	<b>Raw material equivalent of imported products<sup>24</sup></b>
<b>Minerals</b>	Biomass
Ornamental and building stone	Fossil fuels
Limestone, gypsum, chalk	Metal ores
Slate	Minerals
Sand and gravel	<b>Unused extraction of imported products</b>
Clays and kaolin	Unused biomass from harvest
Chemical and fertilizer minerals	Unused extraction from mining & quarrying of fossil fuels
Salt	Unused extraction from mining & quarrying of metal ores
Other mining and quarrying products	Unused extraction from mining & quarrying of minerals
	Soil excavation and dredging

<sup>22</sup> Import (and export) data should be organised at a more detailed level in parallel to the classification of domestic extraction to the extent possible, to allow for aggregation of domestic extraction and imports.

<sup>23</sup> Memorandum items for balancing are not to be included when compiling indicators.

<sup>24</sup> The indirect flows (of used materials) are compiled as raw material equivalents minus the weight of the imports.

Table 5.4: Classification of material outputs

<b>Emissions and wastes</b>	
<b>Emissions to air from combustion and industrial processes</b>	<b>Waste land filled</b>
CO <sub>2</sub>	From private households (and household-type waste from industry and commerce)
SO <sub>2</sub>	From industry and commerce (production waste and construction/demolition waste)
NO <sub>x</sub> as NO <sub>2</sub>	From waste and waste water management activities (sewage sludge, etc.)
VOC (NMVOC excl. solvents and CH <sub>4</sub> excl. CH <sub>4</sub> from landfills)	<b>Emissions to water</b>
CO	Nitrogen (N)
PM - Particulate matter (incl. dust)	Phosphorus (P)
N <sub>2</sub> O excl. use of products and N from agriculture and wastes	Other substances and (organic) materials
NH <sub>3</sub> excl. N from fertilisers	Dumping of materials at sea
CFCs and Halons	
<b>Dissipative use of products and dissipative losses</b>	
<b>Dissipative use of products</b>	
Dissipative use on agricultural land	Dissipative use on roads (thawing and grit materials)
Mineral fertilisers	Dissipative use of other kind (incl. solvents)
Farmyard manure	<b>Dissipative losses</b>
Sewage sludge	Abrasion (tyres, etc.)
Compost	Accidents with chemicals
Pesticides	Leakages (natural gas, etc.)
Seeds	Erosion and corrosion of infrastructures (roads, etc.)
<b>Exports</b> <sup>25</sup> (detailed classification is the same as for imports)	
<b>Memorandum items for balancing</b> <sup>26</sup>	
<b>Water vapour from combustion (H<sub>2</sub>O)</b>	Water content of other materials
From water (H <sub>2</sub> O) contents of fuels	<b>Respiration of humans and livestock</b>
From hydrogen (H) contents of fuels	CO <sub>2</sub>
<b>Water evaporation from products</b>	Water vapour (H <sub>2</sub> O)
Water content of biomass	

Table 5.5: Classification of material stock changes

<b>Total (gross) additions</b>	
<b>Infrastructures and buildings</b>	<b>Other (machinery, durable goods, etc.)</b>
Construction minerals	Metals
Metals	Other materials
Wood	
Other construction materials	
<b>Removals (incl. losses)</b>	
<b>Infrastructures and buildings</b>	<b>Other (machinery, durable goods, etc.)</b>
By demolition	By discard
Construction minerals	Metals
Metals	Other materials
Wood	By dissipative loss
Other materials	Metals
By dissipative loss	Other materials
Construction minerals	
Metals	
Wood	
Other materials	
<b>Net Additions to material Stock (gross additions minus removals)</b>	
<b>Infrastructures and buildings</b>	<b>Other (machinery, durable goods, etc.)</b>
Construction minerals	Metals
Metals	Other materials
Wood	
Other materials	

<sup>25</sup> Export data should be organized at the same level of detail as imports to the extent possible, to allow compilation of physical trade balances by material groups.

<sup>26</sup> Memorandum items for balancing are not to be included when compiling indicators.

#### 4. HIGHLY AGGREGATED EW-MFACC AND DERIVED INDICATORS

In the following sections a system of highly aggregated accounts for EW-MFacc is presented, again by making reference to example figures fully coherent with the full-fledged accounting framework presented in section Chapter 3.6, though adjusted to the new system boundary and classification as in Table 5.1 and Table 5.2. Little or no detail on the kind of the materials included is provided by these accounts. Individual accounts are drawn up so as to aid practical and analytical work. The sequence of these accounts is such that the material flows for which data are more likely to be available are presented first. Progressing through the sequence of accounts, more primary data and compilation work will be required.

Each flow account has two sides. They are called resources and uses. Resources are by convention put on the left side. Other terms could be used for the two sides of the accounts, such as supply and use, origin and destination, inflows and outflows or inputs and outputs. This is not done because most of these latter terms have been used for other purposes.

In the national accounts, the term "resources" is used for the side of the current accounts where transactions which add to the amount of economic value of a unit or sector appear. The uses side of the accounts relates to transactions that reduce the amount of economic value of a unit or sector.

In the sequence of highly aggregated EW-MFacc the flows that add to the amount of material in the national socio-economic system are recorded on the resources side. For example, domestic extraction and imports are recorded on the resources side of the accounts. By extension, the same principle is also applied to unused extraction. On the uses side flows that reduce the amounts of materials in the economy are recorded. For example, exports and emissions are recorded on the uses side.

Furthermore, on the uses side accumulation and balancing items occur. For example, in the PTB account the physical trade balance, and in the Direct Material Flow Balance the net additions to stock appear on the uses side. More generally, indicators always appear on the uses side when they are first derived.

The individual accounts are<sup>27</sup>:

1. Direct Material Input (DMI) account;
2. Domestic Material Consumption (DMC) account;
3. Physical Trade Balance (PTB) account;
4. Direct Processed Output to nature (DPO) account;
- 5a. Net Additions to Stock (NAS) derived as a balance of inputs and outputs;
- 5b. Net Additions to Stock (NAS) directly measured;
6. Direct Material Flows Balance;
7. Unused Domestic Extraction account;
8. Indirect Flows account;
9. Total Material Requirement (TMR) account;
10. Total Material Consumption (TMC) account.

<sup>27</sup> Reference is made to the numbering and names of the accounts of Eurostat's Methodological guide (2001). Account number 6 has not been included as it relates to the quantification of existing socio-economic stocks and not to flows.

#### 4.1.1 Direct Material Input (DMI) account

The first account is to determine DMI. This is done simply by summing up the categories of material flows that constitute it.

1) DMI account	Resources	Uses
<b>Domestic Extraction (Used)</b>	<b>312.600</b>	
<i>Biomass</i>	62.500	
<i>Fossil Fuels</i>	65.100	
<i>Metal Ores</i>	30.000	
<i>Construction Minerals</i>	140.000	
<i>Industrial Minerals</i>	15.000	
<b>Imports</b>	<b>93.400</b>	
<i>Raw Materials</i>	46.700	
<i>Semi-manufactured products</i>	28.000	
<i>Finished Products</i>	17.200	
<i>Packaging materials imported with products</i>	1.500	
<b>Waste imported for final treatment and disposal</b>	<b>0.300</b>	
<b>DMI - Direct Material Input</b>		<b>406.300</b>

#### 4.1.2 Domestic Material Consumption (DMC) account

The second account is to derive DMC as a balancing item by deducting exports from DMI.

2) DMC account	Resources	Uses
<b>Direct Material Input</b>	<b>406.300</b>	
<b>Exports</b>		<b>69.500</b>
<i>Raw Materials</i>		27.800
<i>Semi-manufactured products</i>		21.000
<i>Finished Products</i>		18.700
<i>Packaging materials exported with products</i>		2.000
<b>Waste exported for final treatment and disposal</b>		<b>1.700</b>
<b>DMC - Domestic Material Consumption</b>		<b>335.100</b>

#### 4.1.3 Physical Trade Balance (PTB) account

The third account is to derive the physical trade balance by deducting exports from imports. Hence, a (physical) trade surplus (or net import of materials) occurs when imports exceed exports, and a physical trade deficit (or net export of materials) when exports exceed imports.

3) PTB account	Resources	Uses
<b>Imports</b>	<b>93.400</b>	
<b>Waste imported for final treatment and disposal</b>	<b>0.300</b>	
<b>Exports</b>		<b>69.500</b>
<b>Waste exported for final treatment and disposal</b>		<b>1.700</b>
<b>PTB - Physical Trade Balance</b>		<b>22.500</b>

#### 4.1.4 Direct Processed Output to nature (DPO) account

The fourth account is to determine Domestic Processed Output to nature. This account is put here in the sequence to allow derivation of NAS (see Account 5a). When NAS is derived from gross additions to stock minus removals from stock (see Account 5b), then the DPO account is not strictly necessary at this stage in the sequence of accounts.

4) DPO account	Resources	Uses
<b>Emissions and wastes</b>	<b>342.480</b>	
<i>Emissions to air from combustion and industrial processes</i>	282.030	
<i>Waste landfilled in controlled landfills</i>	39.500	
<i>Waste Landfilled in uncontrolled landfills</i>	20.000	
<i>Emissions to water</i>	0.950	
<b>Dissipative use of products and losses</b>	<b>19.420</b>	
<i>Dissipative use of products</i>	18.500	
<i>Dissipative losses</i>	0.920	
<b>DPO - Domestic Processed Output to nature</b>		<b>361.900</b>

#### 4.1.5 Net Additions to Stock (NAS)

The fifth account is to determine Net Additions to Stock. This can be done in two ways. Account 5a derives NAS as a residual from DMC less DPO (which is a very rough method). Account 5b derives NAS as a residual from gross additions to stock minus discard, demolition and losses from stock. Account 5b should be set up by main material categories.

5a) NAS as balancing item account	Resources	Uses
<b>DMC - Domestic Material Consumption</b>	<b>335.100</b>	
<b>Emissions and wastes</b>		<b>342.480</b>
<b>Dissipative use of products and losses</b>		<b>19.420</b>
<i>Memorandum items for balancing</i>	<b>340.000</b>	<b>171.000</b>
<b>NAS - Net Addition to Stocks</b>		<b>142.200</b>

5b) NAS directly measured	Resources	Uses
<b>Transport infrastructure and Buildings</b>	<b>128.800</b>	
<i>Gross additions</i>	143.400	
<i>demolition</i>	14.600	
<b>Machinery</b>	<b>14.200</b>	
<i>Gross additions</i>	16.000	
<i>dismissed</i>	1.800	
<b>Other durables</b>	<b>4.600</b>	
<i>Gross additions</i>	6.400	
<i>dismissed</i>	1.800	
<b>Inventory changes</b>	<b>-7.100</b>	
<b>Live animals</b>	<b>1.700</b>	
<b>Total NAS - Net Addition to Stocks</b>	<b>142.200</b>	

#### 4.1.6 Direct Material Flows Balance

The above accounts allow to present a flow balance (in which inputs and outputs are equal) for direct material inputs and outputs.

<b>6) Direct Material Flows Balance</b>	Resources	Uses
<b>Domestic Extraction (Used)</b>	<b>312.600</b>	
<b>Imports</b>	<b>93.400</b>	
<b>Waste imported for final treatment and disposal</b>	<b>0.300</b>	
<b>Emissions and Wastes</b>		<b>342.480</b>
<b>Dissipative use of products and losses</b>		<b>19.420</b>
<b>Exports</b>		<b>69.500</b>
<b>Waste exported for final treatment and disposal</b>		<b>1.700</b>
<b>Net Addition to Useful Stocks</b>		<b>142.200</b>
<b>Memorandum items for balancing</b>	<b>340.000</b>	<b>171.000</b>
<b>Total</b>	<b>746.300</b>	<b>746.300</b>

#### 4.1.7 Unused Domestic Extraction account

Account 7 simply presents unused domestic extraction (with inputs and outputs being equal by definition). Combining this account with the DMI account (Account 1) allows derivation of domestic TMR and combination with the DPON account (Account 4) allows derivation of TDO (Total Domestic Output to nature).

<b>7) Unused Domestic Extraction account</b>	Resources	Uses
<b>Unused Domestic Extraction</b>	<b>98.000</b>	<b>98.000</b>
<i>from mining/quarrying</i>	<i>55.000</i>	<i>55.000</i>
<i>from biomass harvest</i>	<i>3.000</i>	<i>3.000</i>
<i>soil excavation</i>	<i>40.000</i>	<i>40.000</i>

#### 4.1.8 Indirect Flows account

Account 8 presents a physical trade balance for indirect flows. Note that international trade flows and associated indirect flows can be quite complex and need further research. For example, additional categories for 're-export (re-import) of indirect flows associated to imports (exports)' may be considered. For the uses side, the indirect flows associated to exports could be separated into domestic indirect flows and imported indirect flows associated to the production of the products exported.

<b>8) Physical Trade Balance including Indirect Flows</b>	Resources	Uses
<b>Imports</b>	<b>93.400</b>	
<b>Waste imported for final treatment and disposal</b>	<b>0.300</b>	
<b>Indirect flows associated to imports</b>	<b>326.900</b>	
<b>Exports</b>		<b>69.500</b>
<b>Waste exported for final treatment and disposal</b>		<b>1.700</b>
<b>Indirect flows associated to exports</b>		<b>208.500</b>
<b>Physical Trade Balance including Indirect Flows</b>		<b>140.900</b>

#### 4.1.9 Total Material Requirement (TMR) account

Account 9 summarises the Accounts 1, 8 and 9 to calculate TMR.

9) TMR account	Resources	Uses
Domestic Extraction (Used)	312.600	
Imports	93.400	
Waste imported for final treatment and disposal	0.300	
Unused Domestic Extraction	98.000	
Indirect flows associated to imports	326.900	
<b>TMR - Total Material Requirement</b>		<b>831.200</b>

#### 4.1.10 Total Material Consumption (TMC) account

Account 10 is to derive TMC by deducting exports and indirect flows associated to exports from TMR.

10) TMC account	Resources	Uses
TMR - Total Material Requirement	831.200	
Exports		69.500
Waste exported for final treatment and disposal		1.700
Indirect flows associated to exports		208.500
<b>TMC - Total Material Consumption</b>		<b>551.500</b>

## 5. THE COMPOSITE MATERIAL BALANCE – DERIVATION OF AGGREGATE INDICATORS

The considerations and the accounts can be summarised in a composite material balance (see Figure 5.2) that allows the derivation of several aggregate material-related indicators. The balance in Figure 5.2 is called 'composite' because it shows all the items important for the full set of EW-MFA in a summary form but is not actually used for balancing purposes. In practical work, a Direct Material Flow Balance is set up which will be the last step (data reconciliation) after the individual accounts for main categories of inputs, outputs and stock changes have been made. These individual accounts are sub-sets of the composite balance and include a Direct Material Input Account, a Physical Trade Balance Account, an Unused Domestic Extraction Account and a Total Material Requirements Account.

The composite balance allows the calculation of aggregate material consumption indicators, as follows:

DMC (Domestic Material Consumption) = Domestic Extraction (Used) plus Imports minus Exports;

A Physical Trade Balance (PTB) may be defined as Imports minus Exports;

TMC (Total Material Consumption) = TMR (Domestic Extraction (Used and Unused) + Imports + indirect flows imported) minus Exports minus indirect flows exported.

When the appropriate memorandum items for balancing are introduced, the indicators derived on the input and the output side can be linked by accounting identities. For example, DMI equals DPO plus NAS plus Exports, or NAS equals DMC minus DPO.

**Figure 5.2: Composite economy-wide material balance with derived resource use indicators**

<b>INPUTS (origin)</b>	<b>OUTPUTS (destination)</b>
<b>Domestic Extraction (Used)</b> Fossil fuels (coal, oil...) Minerals (ores, sand...) Biomass (timber, cereals...)	<b>Emissions and Wastes</b> Emissions to air Waste landfilled Emissions to water
<b>Imports</b>	<b>Dissipative use of products and losses</b> (fertiliser, manure, seeds; corrosion...)
<b>DMI - Direct Material Input</b>	<b>DPO - Domestic Processed Output to nature</b>
<b>Unused Domestic Extraction</b> from mining/quarrying from biomass soil excavation	<b>Disposal of Unused Domestic Extraction</b> from mining/quarrying from biomass soil excavation
<b>TMI - Total Material Input</b>	<b>TDO - Total Domestic Output to nature</b>
	<b>Exports</b>
	<b>TMO - Total Material Output</b>
<b>Indirect flows associated to imports</b>	
<b>TMR - Total Material Requirements</b>	<b>Net Additions to Stock</b> Infrastructures and buildings Other (machinery, durable goods, etc.)
	<b>Indirect flows associated to exports</b>

*Note: Excludes water and air flows (unless contained in other materials).*

The above presentation employs classifications that emphasise different aspects on the input and on the output side, namely direct economic use of materials on the input side (Direct Material Inputs versus unused extraction and indirect flows) and environmental pressures (outputs to the domestic environment versus exports and additions to stocks) on the output side.

Applying these basic classification principles differently, further aggregates could be defined. For example, an aggregate for *Direct Material Output* (DMO) may be defined as DPO (Domestic Processed Output to nature) plus Exports. This is the basis for the Direct Material Flow Balance defined as DMI (Domestic Extraction (used) plus Imports) = DMO (Domestic Processed Output to nature plus Exports) plus NAS (Net Additions to Stocks). This balance also requires the introduction of memorandum items for balancing.

## 6. RECONCILIATION BETWEEN EW-MFACC INDICATORS AND SNA-COHERENT MEASURES

Reconciliation between EW-MFACC indicators and SNA-coherent measures of the cross-boundary and accumulation flows of the socio-economic system

Table 5.6: Reconciliation Table

RESOURCES		USES	
<b>Fully SNA-coherent material flow balance of the national socio-economic system</b>			
<b>Cross-boundary flows</b>			
N - All natural resources	270.000	N - All natural resources	-
E - All ecosystem inputs	425.000	E - All ecosystem inputs	-
P - All products (Imports)	98.400	P - All products (Exports)	71.500
W - All residuals	0.400	W - All residuals	544.700
<i>imported</i>	0.300	<i>exported</i>	1.700
<i>reclaimed from the natural environment</i>	0.100	<i>emitted to the natural environment</i>	543.000
<b>Total Inputs</b>	<b>793.800</b>	<b>Total Outputs</b>	<b>616.200</b>
<b>Net additions to stocks</b>			
		<i>Additions of products to useful stocks</i>	160.400
		<i>minus residuals from useful stocks</i>	- 18.200
		<i>residuals to controlled landfills</i>	39.500
		<i>minus residuals from controlled landfills</i>	- 4.100
<i>Net additions to stocks</i>			<b>177.600</b>
<b>TOTAL FLOWS - SNA system boundary</b>	<b>793.800</b>		<b>793.800</b>
<b>Changes to go from residence- to territory-principle-based accounting</b>			
<b>a) Adjustment for flows of resident units abroad, not included in EW-MFAcc aggregates</b>			
Products purchased abroad by resident units, to be subtracted from imports	- 5.000	minus Residuals produced by resident units operating abroad	- 20.000
Fuels	- 4.000	from fuels' consumption	- 18.800
Food	- 1.000	from human metabolism	- 1.200
minus Ecosystem inputs and natural resources from the rest of the world	- 15.000		
for fuels combustion	- 14.800		
for respiration	- 0.200		
<b>b) Adjustments for flows of non-resident operating on the national territory</b>			
plus Ecosystem inputs and natural resources from the national environment used by non-resident units	5.000	Products purchased on the national territory by non-resident units, to be plus Residuals produced by non-resident units operating on the national	- 2.000 7.000
<b>Territory principle-based material flow balance of the national socio-economic system</b>			
<b>Cross-boundary flows</b>			
N - All natural resources	270.000	N - All natural resources	-
E - All ecosystem inputs	415.000	E - All ecosystem inputs	-
<i>SNA-coherent value</i>	425.000	P - All products (Imports)	69.500
<i>adjustment of ecosystem inputs</i>	- 10.000	<i>SNA-coherent value</i>	71.500
P - All products (Imports)	93.400	<i>adjustment of exports</i>	- 2.000
<i>Imports</i>	98.400	W - All residuals	531.700
<i>adjustment of imports</i>	- 5.000	<i>SNA-coherent value</i>	544.700
W - All residuals	0.400	<i>adjustment of emissions to the natural environment</i>	- 13.000
<b>Total Inputs</b>	<b>778.800</b>	<b>Total Outputs</b>	<b>601.200</b>
<b>Net additions to stocks</b>			
		<i>Additions of products to useful stocks</i>	160.400
		<i>minus residuals from useful stocks</i>	- 18.200
		<i>residuals to controlled landfills</i>	39.500
		<i>minus residuals from controlled landfills</i>	- 4.100
<i>Net additions to stocks</i>			<b>177.600</b>
<b>TOTAL FLOWS - SNA system boundary but for territory principle</b>	<b>778.800</b>		<b>778.800</b>
<b>From SNA-coherent system boundary (but for disregard of residence principle) to EW-MFAcc system boundary</b>			
<b>c) Adjustments for the different treatment of cultivated plants (outside the socio-economic system boundary of EW-MFAcc)</b>			
minus Ecosystem input Water absorbed by cultivated plants		plus fertilisers absorbed by plants, to be added to dissipative use of	3.000
minus Water as a Natural Resource			
plus Water as a Balancing Item	15.000		
minus Ecosystem input CO2 and nutrients for cultivated plants	- 65.000	minus Oxygen produced by cultivated plants	- 33.500
plus Cultivated plants used, included in Domestic Extraction, along with non-cultivated biomass	57.500	minus unused residuals from cultivated plants	- 2.000
<b>d) Adjustments for the different treatment of controlled landfills (Should be treated as separate stocks of the socio-economic system. However in practice it may be difficult to implement the distinction between controlled and uncontrolled landfills)</b>			
		minus polluting air emissions from controlled landfills	- 1.000
		minus non-polluting air emissions from controlled landfills	- 3.000
		minus leakages from controlled landfills	- 0.100
		<i>Classification change: Residuals to controlled landfills change classification</i>	39.500
<b>e) Other classification issues</b>			
Residuals reclaimed from the environment are included in Domestic Extraction	0.100	<i>Non-polluting gaseous residuals other than Oxygen produced by cultivated plants, such as water vapor and oxygen are classified as Output balancing items</i>	171.000
Water taken from the environment as a Natural Resource or Ecosystem Input and incorporated into products is included in Input Balancing Items	15.000	<i>Manure and fertilisers (whether absorbed by cultivated plants, or not), solvents and similar flows of residuals are classified as Dissipative uses of products</i>	19.420
<b>EW-MFAcc material flow balance</b>			
<b>Cross-boundary flows</b>			
DE - Domestic Extraction = Natural resources minus Water as a Natural Resource plus Cultivated plants	312.600	Exports	69.500
Imports	93.400	Waste exported for final treatment and disposal	1.700
Waste imported for final treatment and disposal	0.300	Emissions and wastes	342.480
		Dissipative use of products and losses	19.420
Input balancing items = Ecosystem Inputs minus Water absorbed by cultivated plants minus CO2 and nutrients absorbed by cultivated plants plus water as a Balancing Item	340.000	BO - Output balancing items	171.000
<b>Total Inputs: DMI-Input balancing items</b>	<b>746.300</b>	<b>Total Outputs</b>	<b>604.100</b>
<b>Net additions to stocks</b>			
		<i>Additions of products to useful stocks</i>	160.400
		<i>minus residuals from useful stocks</i>	- 18.200
<b>Net additions to stocks</b>			<b>142.200</b>
<b>TOTAL FLOWS - EW-MFAcc system boundary</b>	<b>746.300</b>		<b>746.300</b>

## REFERENCES

- Eurostat (2001), *Economy-wide material flow accounts and derived indicators – A methodological guide*. European Communities, Luxembourg, [http://epp.eurostat.ec.europa.eu/cache/ITY\\_OFFPUB/KS-34-00-536/EN/KS-34-00-536-EN.PDF](http://epp.eurostat.ec.europa.eu/cache/ITY_OFFPUB/KS-34-00-536/EN/KS-34-00-536-EN.PDF).
- Femia, A. (2007), *An experimental application of reduced PIOTs and PSUTs*, paper prepared for the London Group on Environmental Economic Accounting Meeting, 26-30 March 2007, Johannesburg, South Africa, [http://unstats.un.org/UNSD/envAccounting/londongroup/meeting11/ISTAT\\_An\\_experimental\\_application.pdf](http://unstats.un.org/UNSD/envAccounting/londongroup/meeting11/ISTAT_An_experimental_application.pdf).
- Schoer, K. (2006), *Calculation of direct and indirect material inputs by type of raw material and economic activities*, Paper presented at the London Group on Environmental Economic Accounting Meeting 19 – 21 June 2006, Wiesbaden, Germany, [www.destatis.de](http://www.destatis.de).
- United Nations, European Commission, International Monetary Fund, Organisation for Economic co-operation and Development and World Bank (1993), *System of National Accounts*, <http://unstats.un.org/unsd/sna1993/introduction.asp>.
- United Nations, European Commission, International Monetary Fund, Organisation for Economic co-operation and Development and World Bank (2003), *Handbook of National Accounting – Integrated Environmental and Economic Accounting 2003*, <http://unstats.un.org/unsd/envAccounting/seea2003.pdf>.